

1 Fold in half

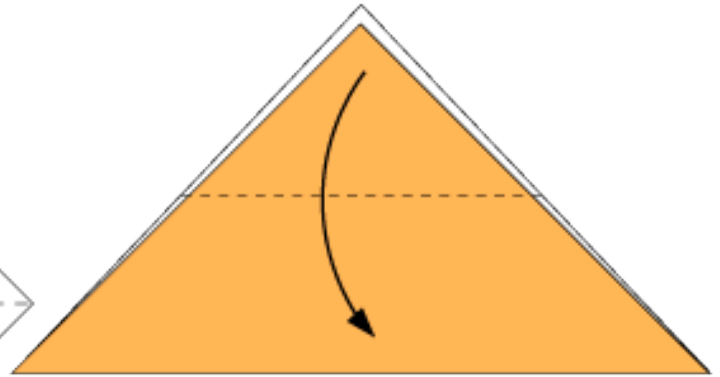

2 Fold in the dotted line

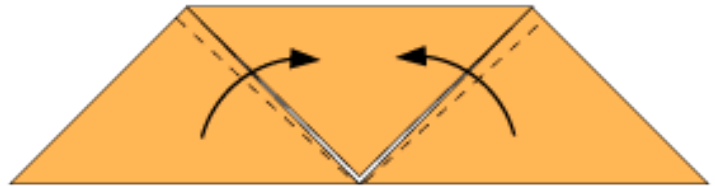

4 Fold in the dotted line

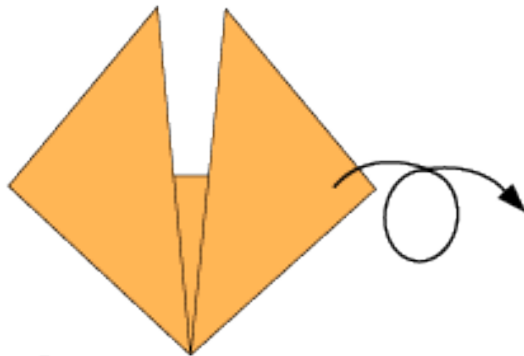

3 Turn over

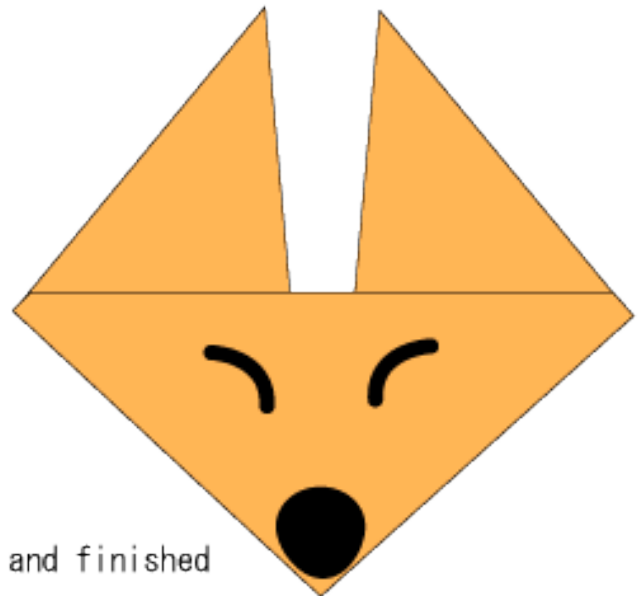

5 Draw eyes, a nose and finished

A Fox (face)

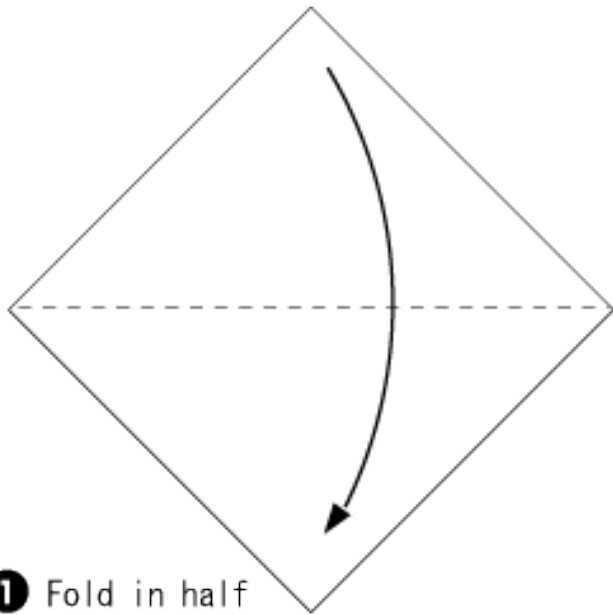

1 Fold in half

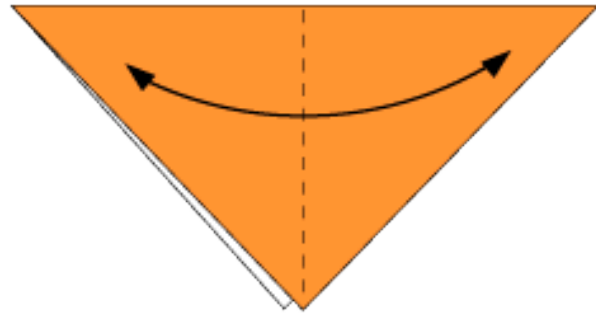

2 Fold in half to make crease

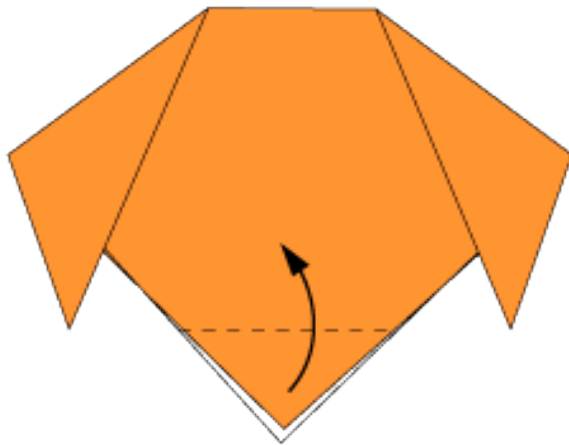

3 Fold in the dotted line

4 Fold in the dotted line

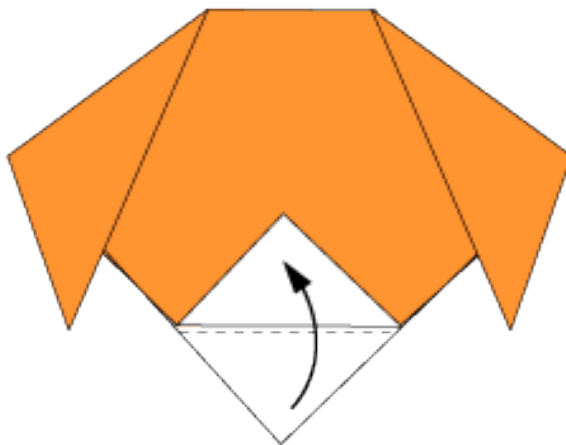

5 Fold in the dotted line

6
Draw a
face and
finished

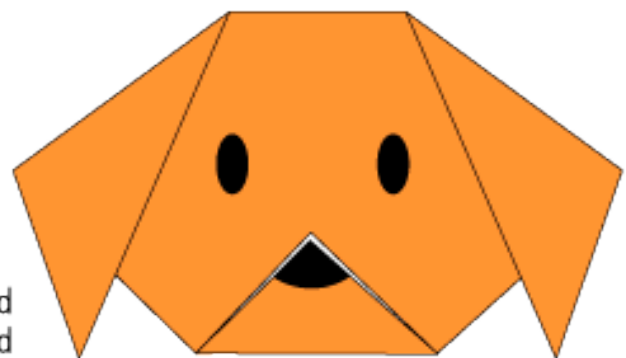

A Dog (face)

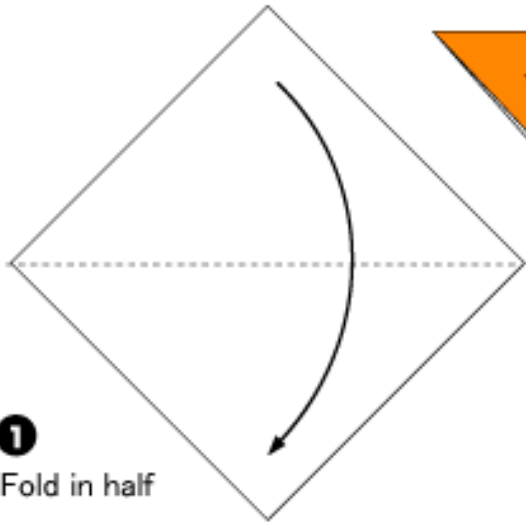

1
Fold in half

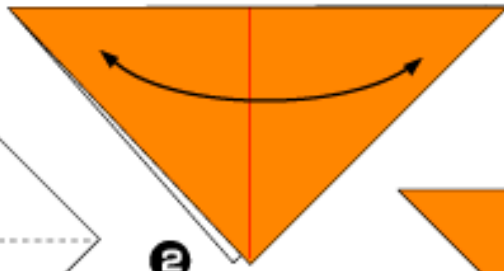

2
Fold in half to make crease
and fold back

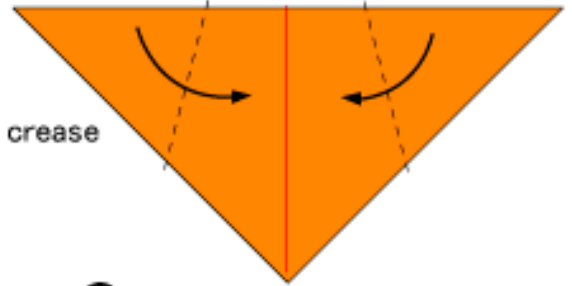

3 Fold in the dotted line

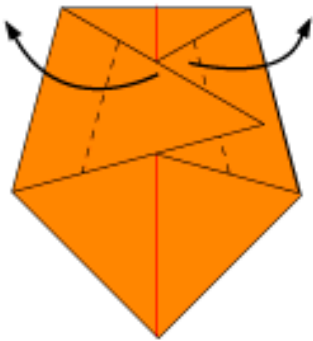

4 Fold in the dotted line

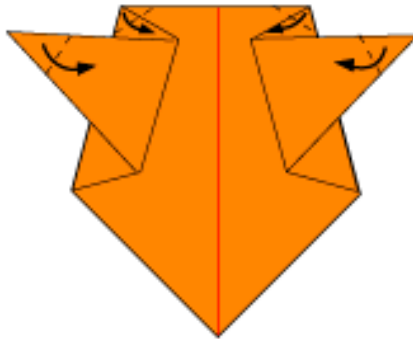

5 Fold in the dotted line

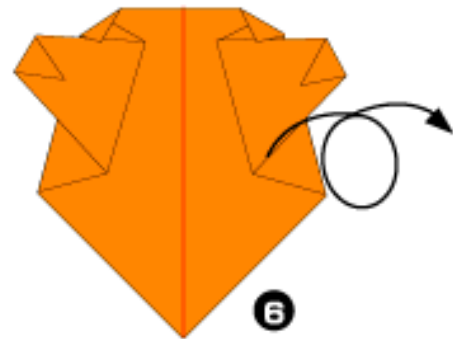

6
Turn over

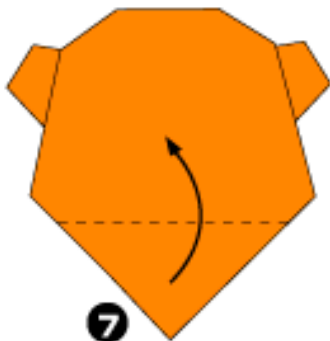

7
Fold in the dotted line

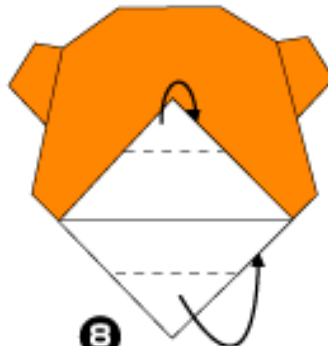

8
Fold backward in
the dotted line

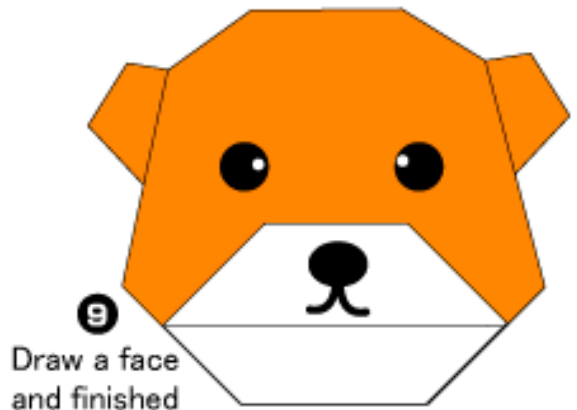

9
Draw a face
and finished

A Bear (face)

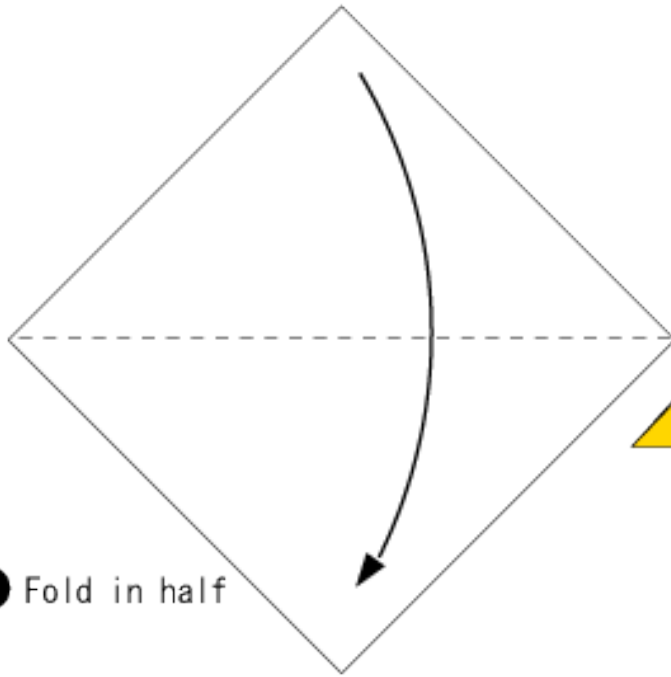

1 Fold in half

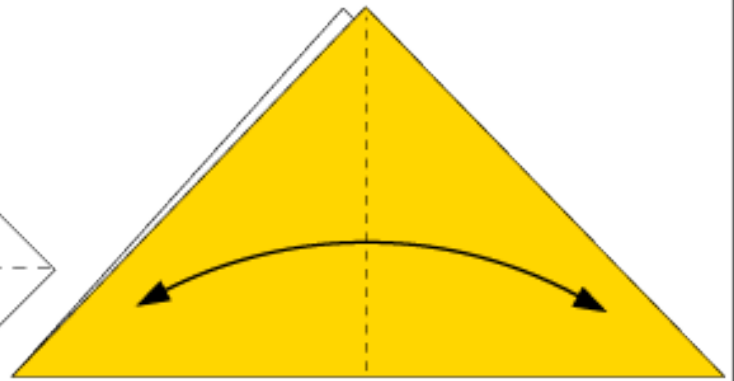

2 Fold in half to make crease

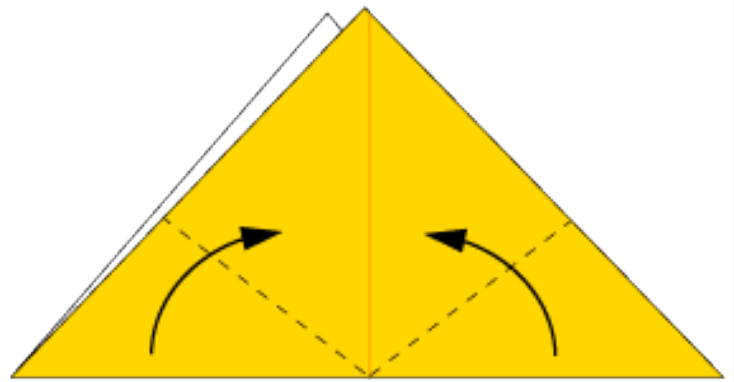

3 Fold in the dotted line

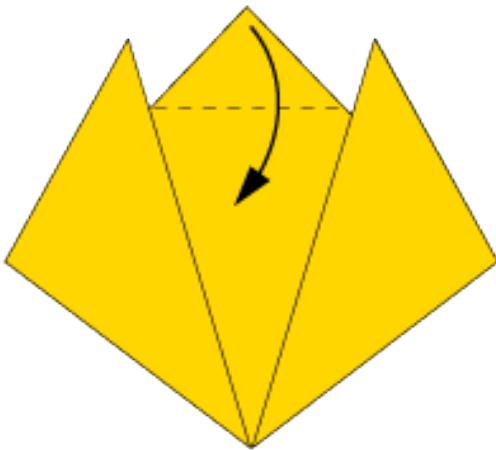

4 Fold in the dotted line

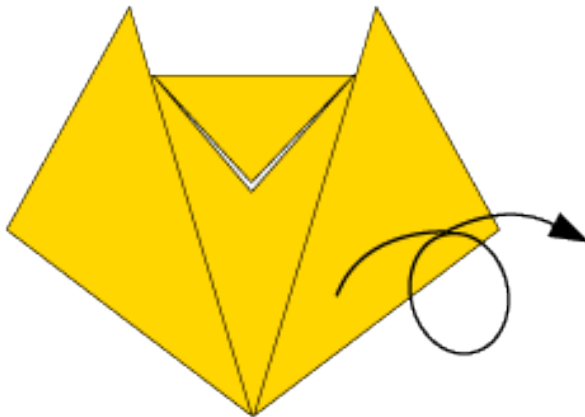

5 Turn over

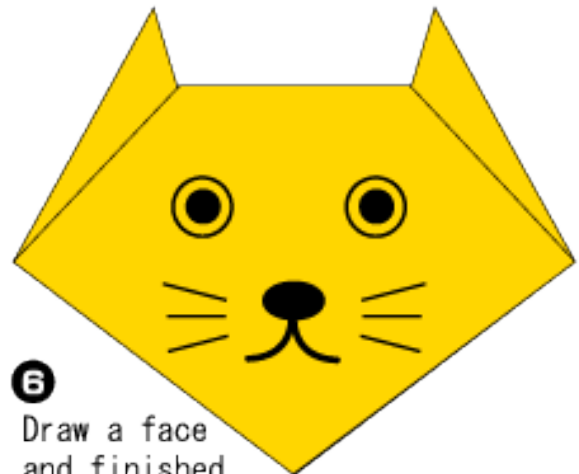

6 Draw a face and finished

A Cat

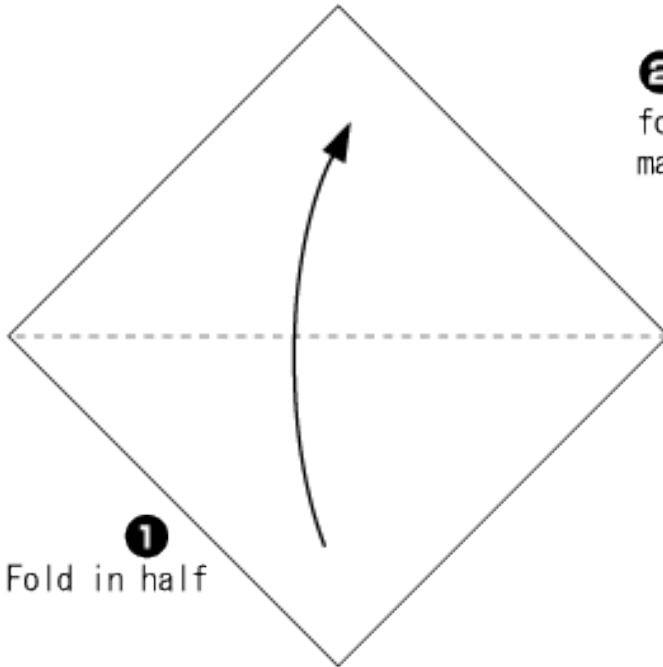

1
Fold in half

2
fold in half to
make crease

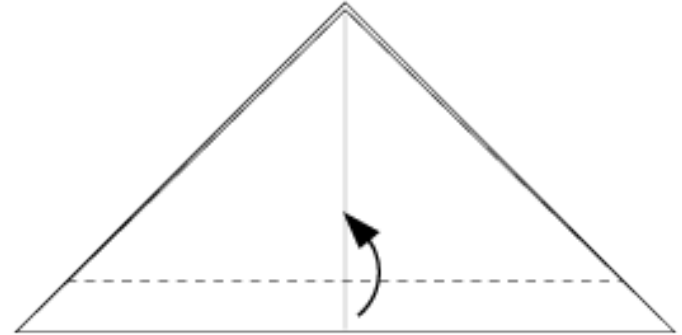
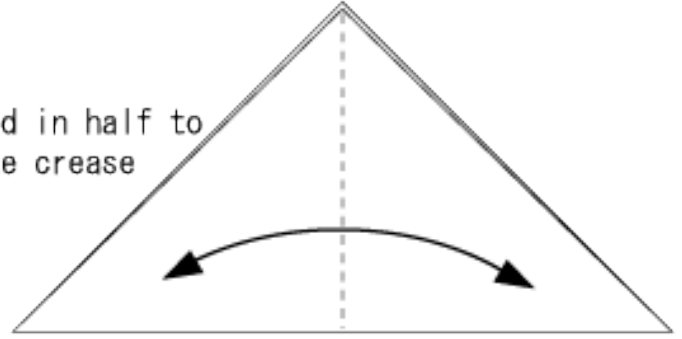

3 Fold in the dotted line

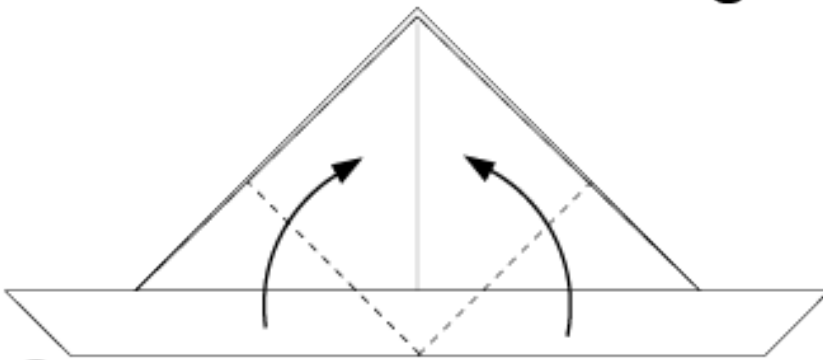

4 Fold to meet the center line
along the crease

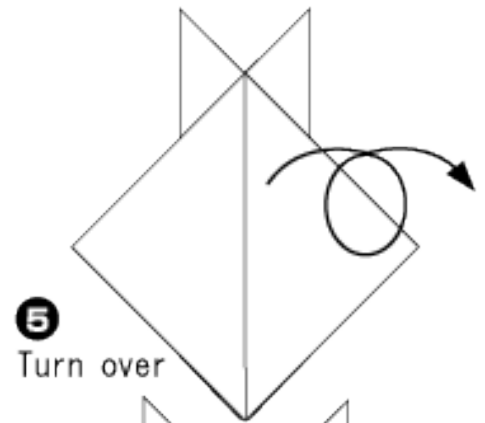

5
Turn over

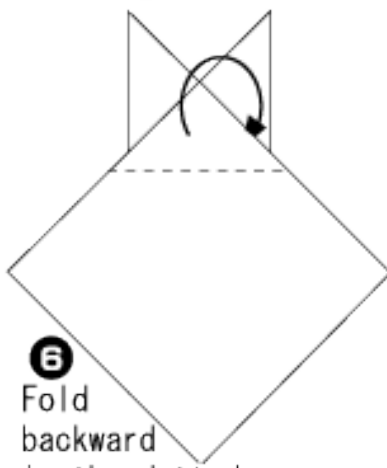

6
Fold
backward
in the dotted
line

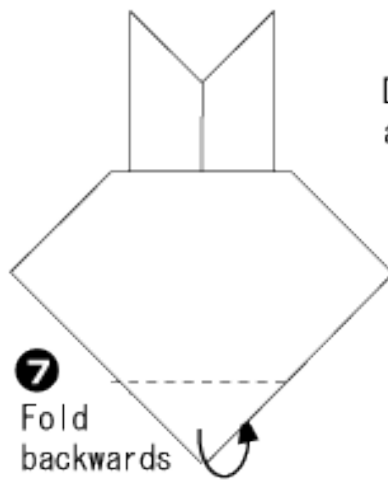

7
Fold
backwards
in the dotted
line

8
Draw a face
and finished

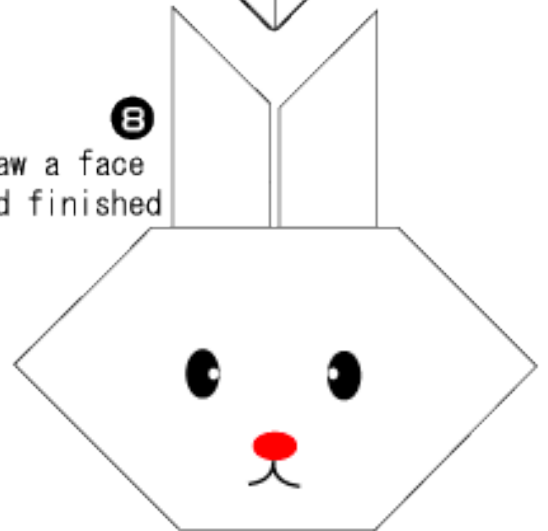

A Rabbit (face)

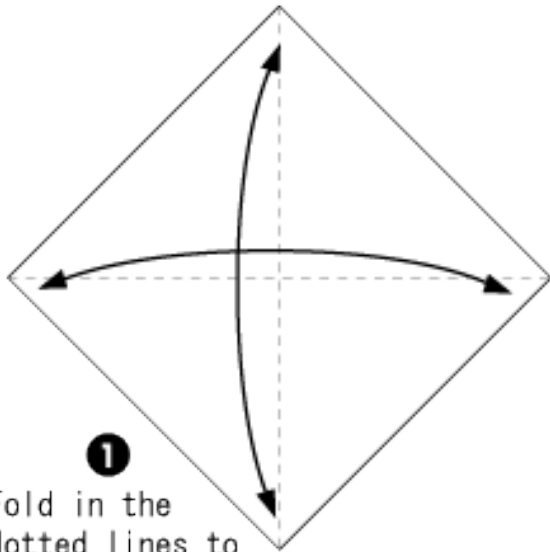

1

Fold in the dotted lines to make creases and fold back

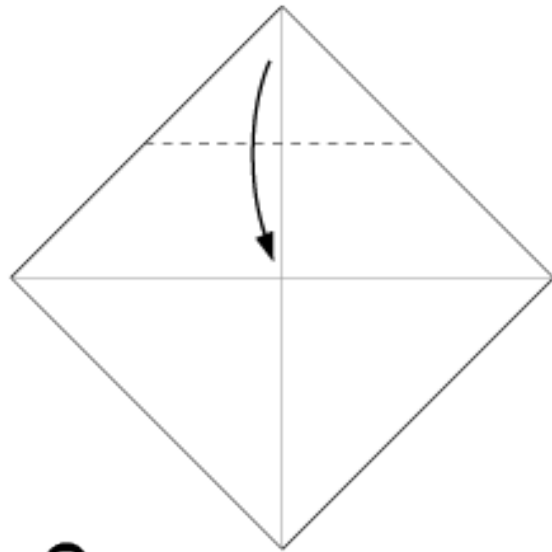

2

Fold in the dotted line

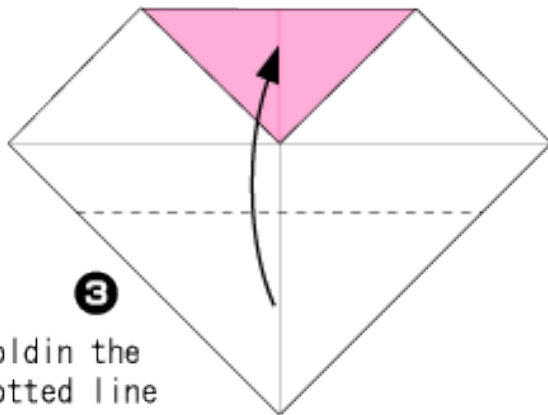

3

Fold in the dotted line

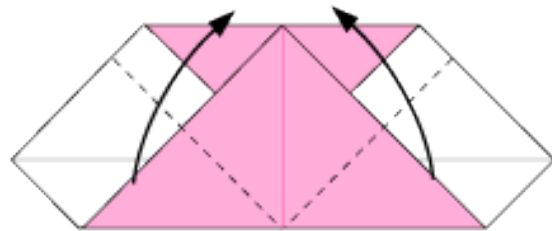

4

Fold in the dotted lines

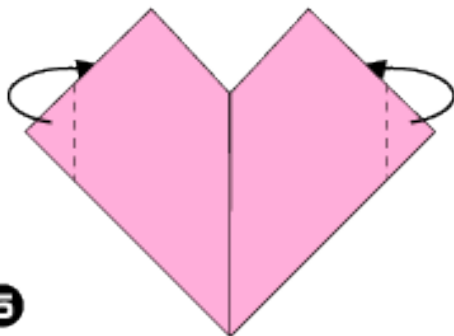

5

Fold backward in the dotted lines

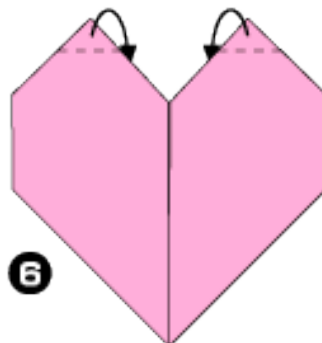

6

Fold backward in the dotted lines

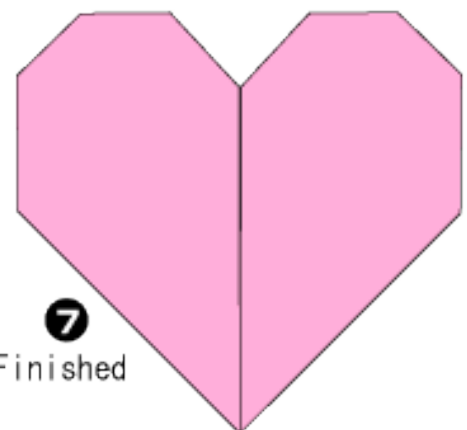

7

Finished

An Easy Heart

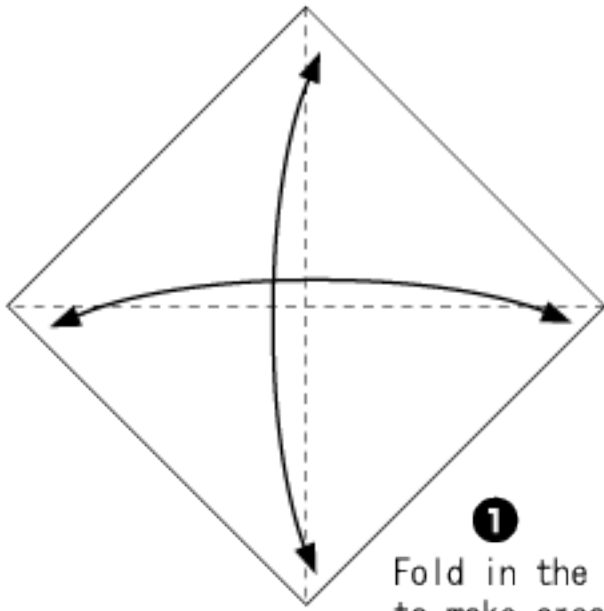

1
Fold in the dotted lines
to make creases and fold back

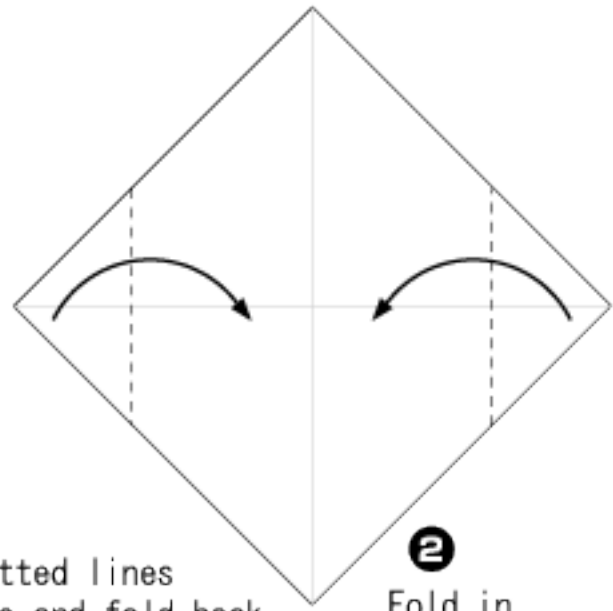

2
Fold in
the dotted line

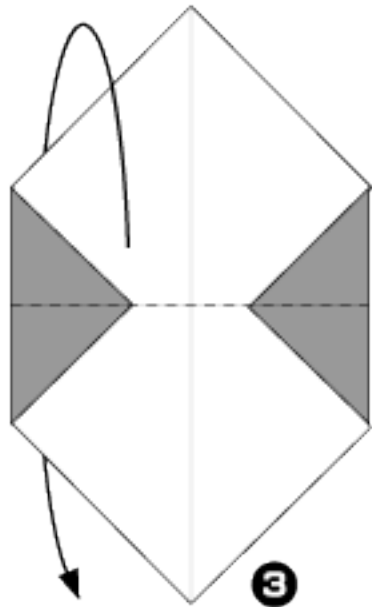

3
Fold in half

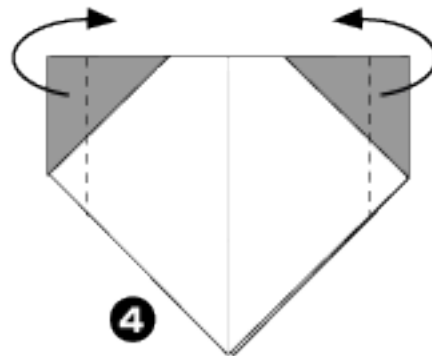

4
Fold backward
in the dotted line

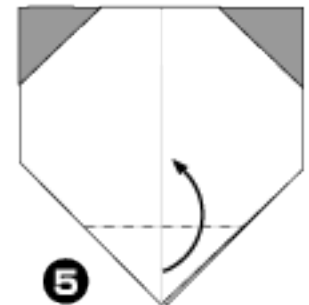

5
Fold in
the dotted line

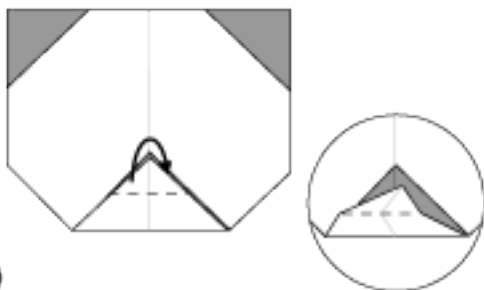

6
Fold inside the white one

Draw eyes
and finished

7

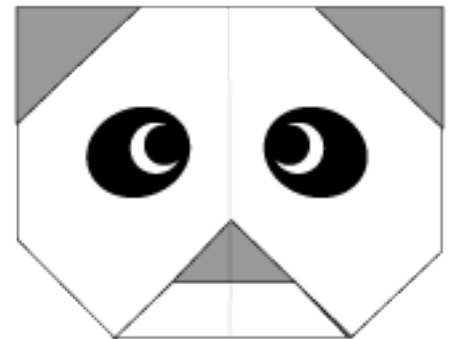

A Panda (face)

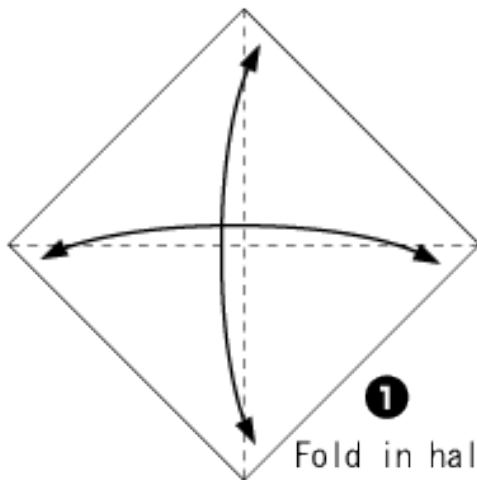

1
Fold in half twice to
make creases and fold back

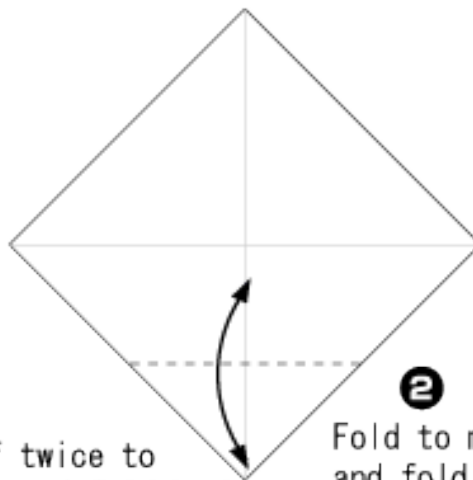

2
Fold to make a crease
and fold back

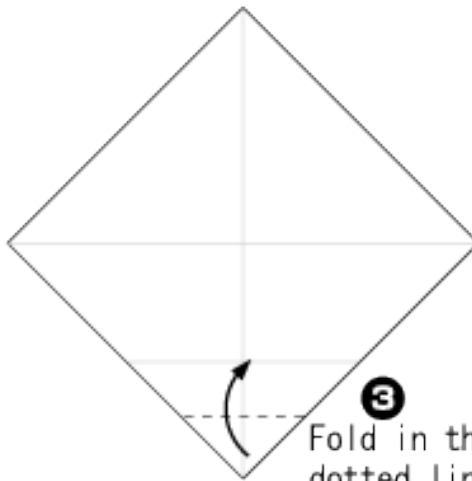

3
Fold in the
dotted line

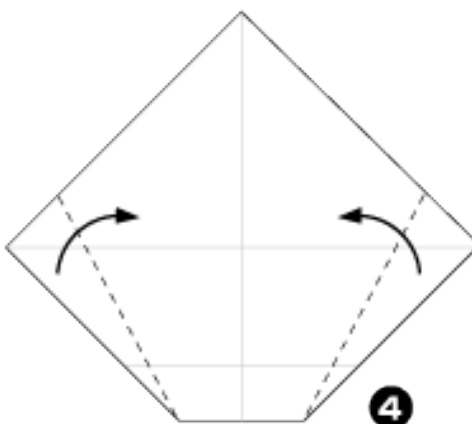

4
Fold in the
dotted line

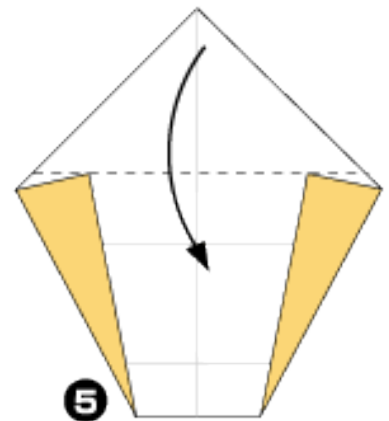

5
Fold in the
dotted line

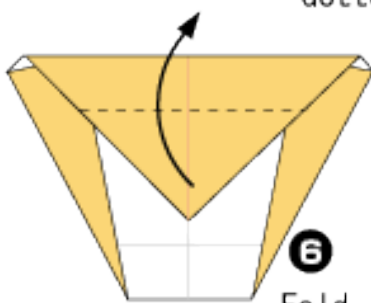

6
Fold in the
dotted line

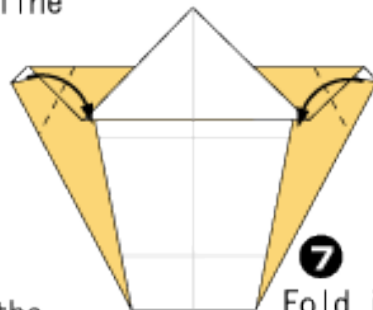

7
Fold in the
dotted line

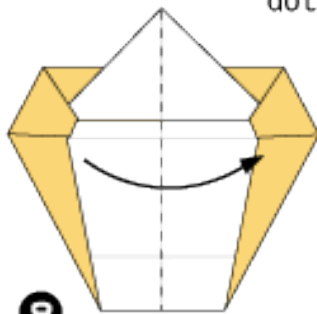

8
Fold in half

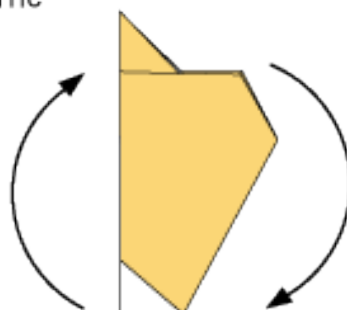

9
Turn around

Draw a face
and finished

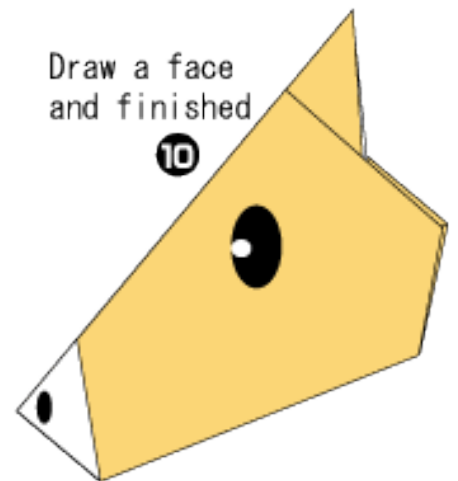

10

A Horse(face)

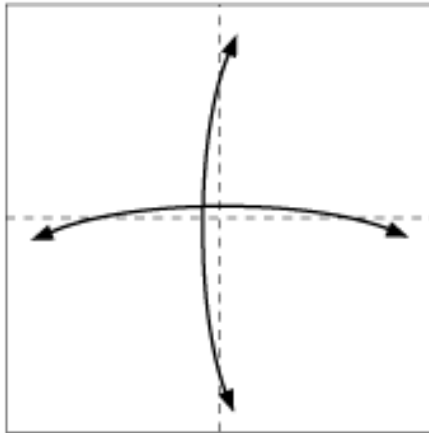

1 Fold in half twice to make creases and fold back

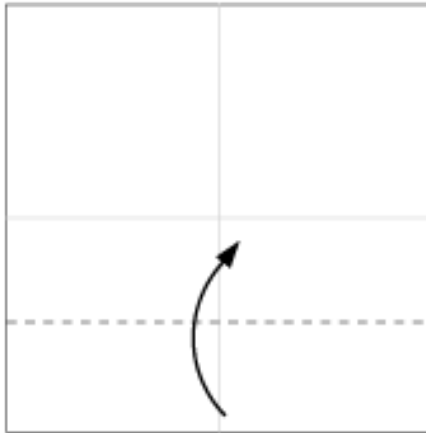

2 Fold to meet the center line

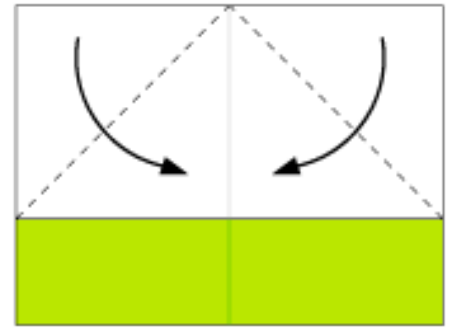

3 Fold to meet the center line

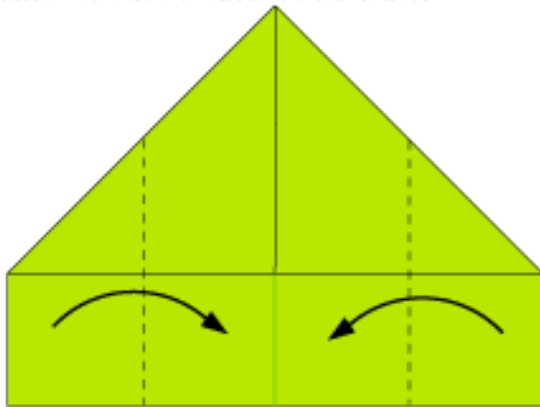

4 Fold to meet the center line

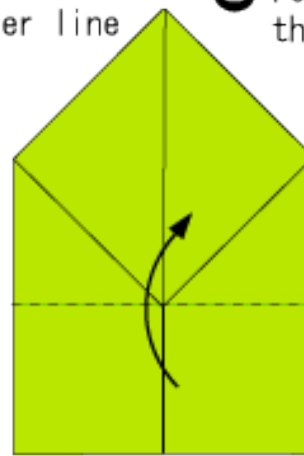

5 Fold in the dotted line

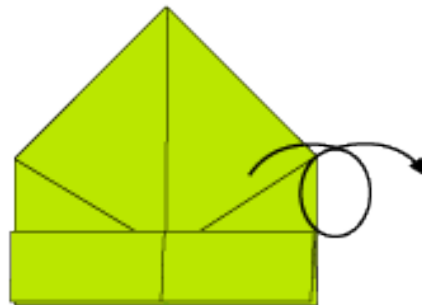
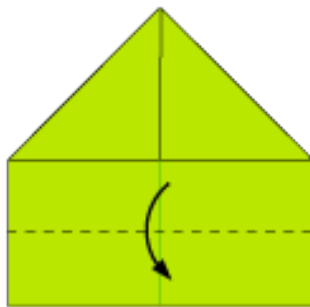

6 Fold in the dotted line **7** Turn over

It overturns when strongly pushing



It jumps when a little pushing.



8 Finished

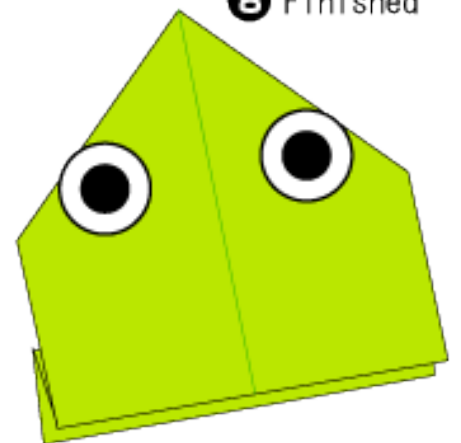

Overturns Frog

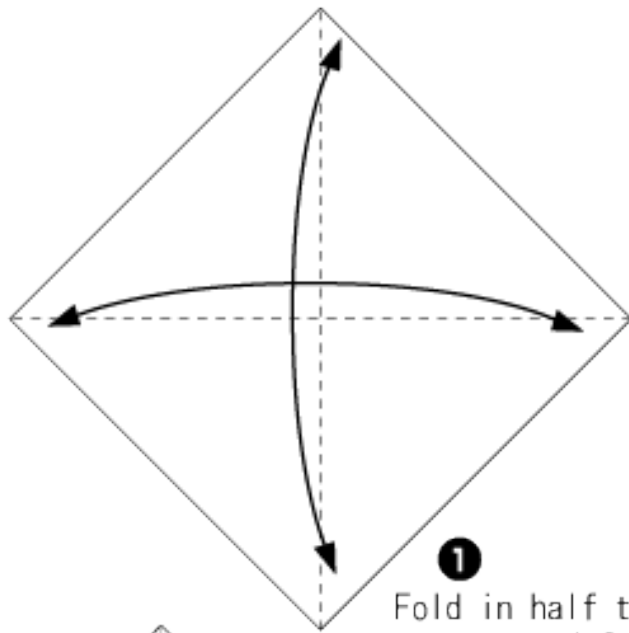

1 Fold in half twice to make creases and fold back

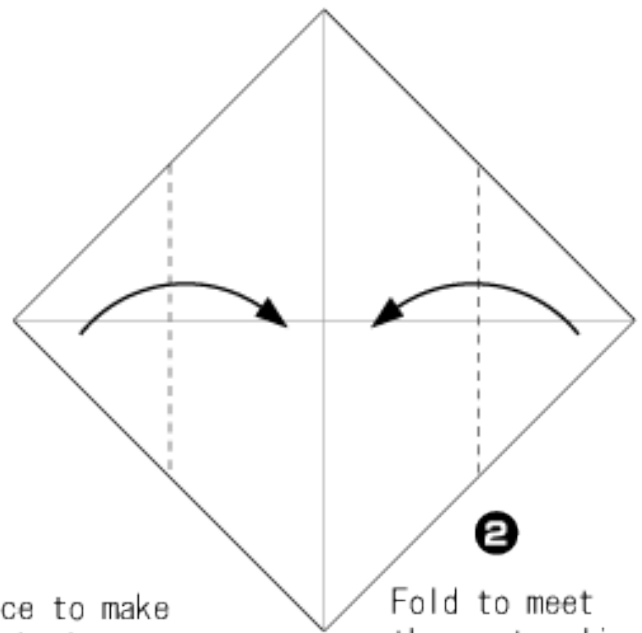

2 Fold to meet the center line

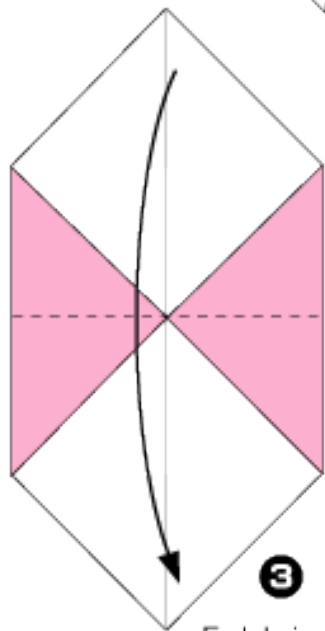

3 Fold in half

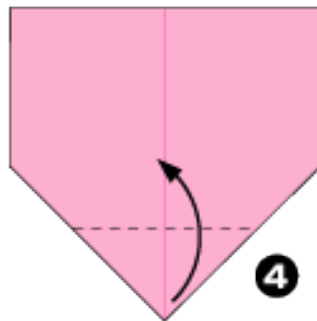

Fold in the dotted line

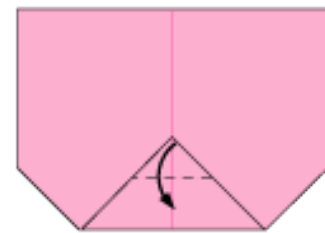

5 Fold in the dotted line

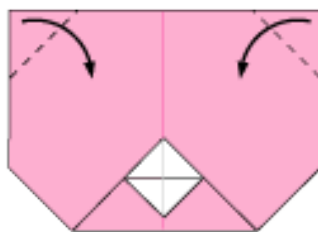

6 Fold in the dotted line

Draw a face and finished

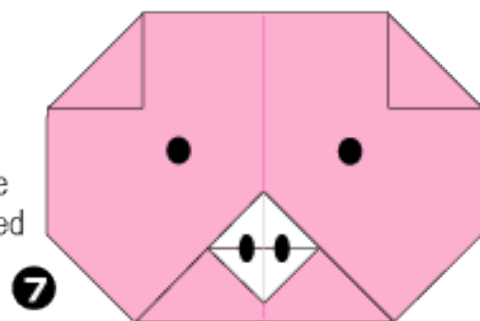

7

A Pig

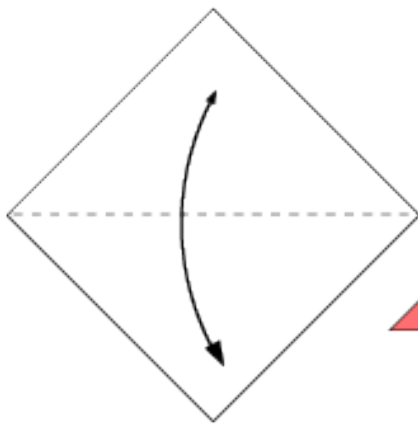

1 Fold in half

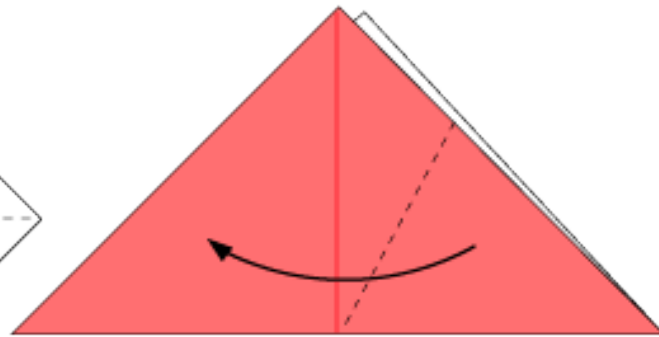

2 Fold in the dotted line

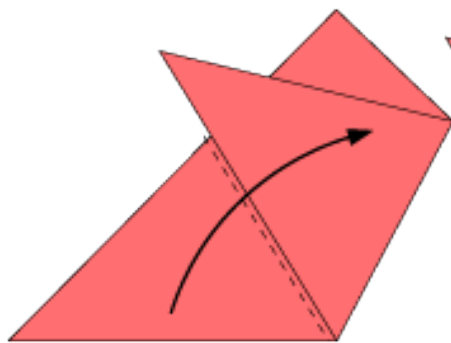

3 Fold in the dotted line

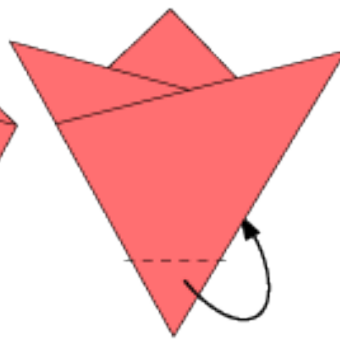

4 Fold backward in the dotted line

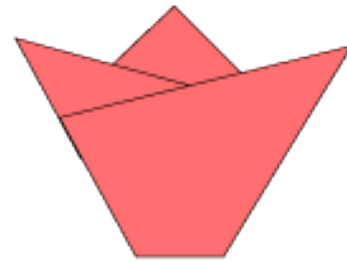

5 Finished, but it's only got half way. Let's move to the next part below

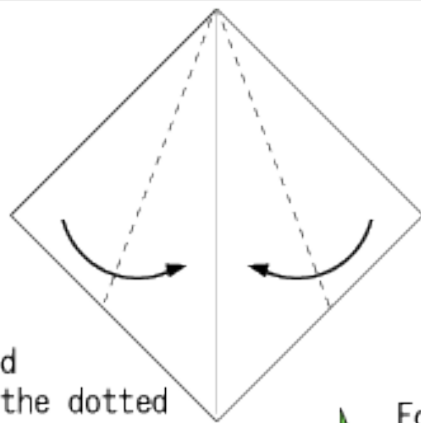

1 Fold in the dotted line

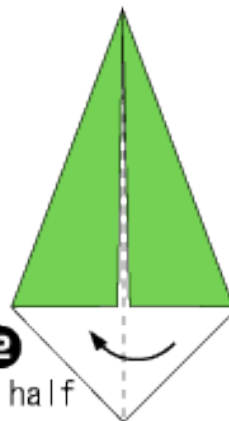

2 Fold in half



3 Fold in the dotted line

4 Stick them together and finished

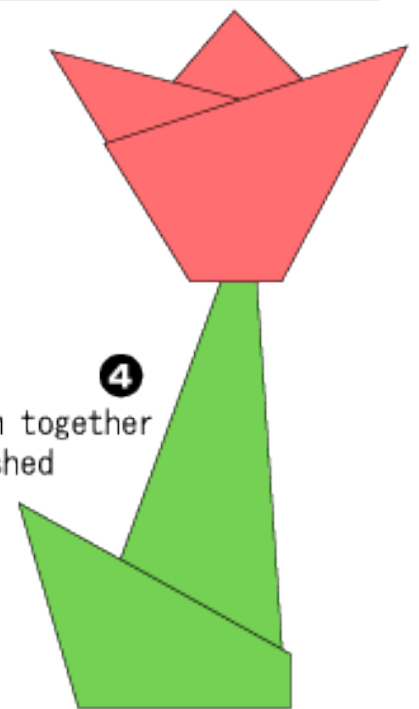

A Tulip

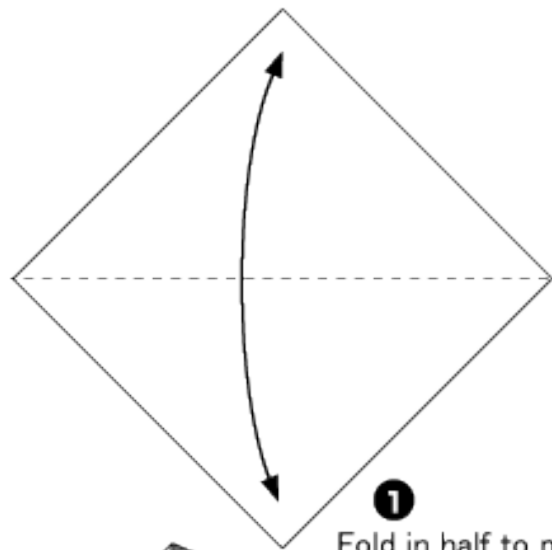

1 Fold in half to make crease and fold back

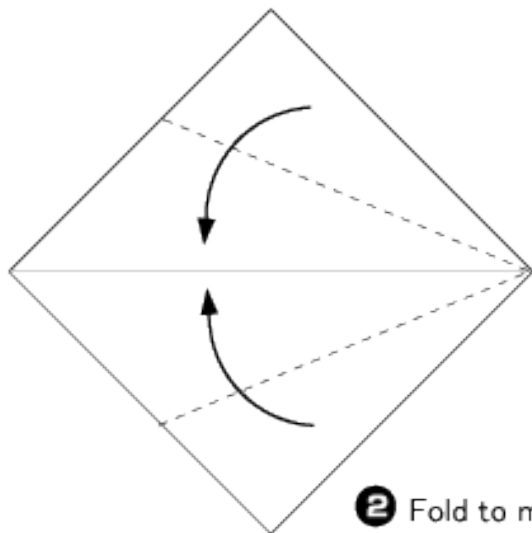

2 Fold to meet the center line

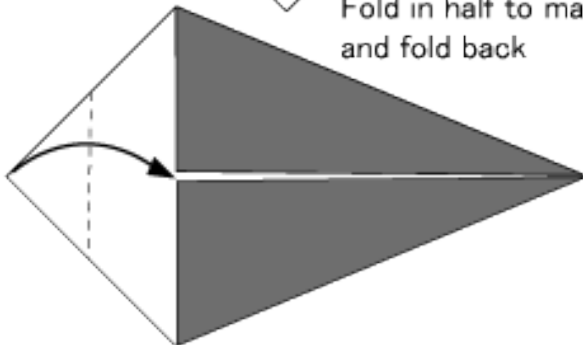

3 Fold in the dotted line

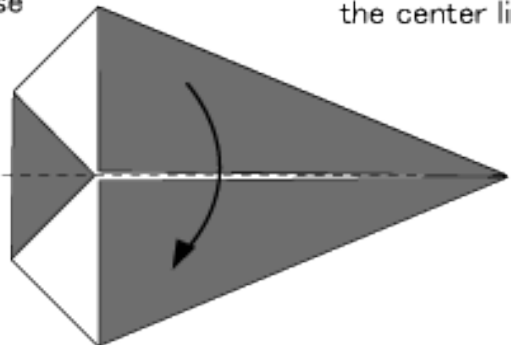

4 Fold in half

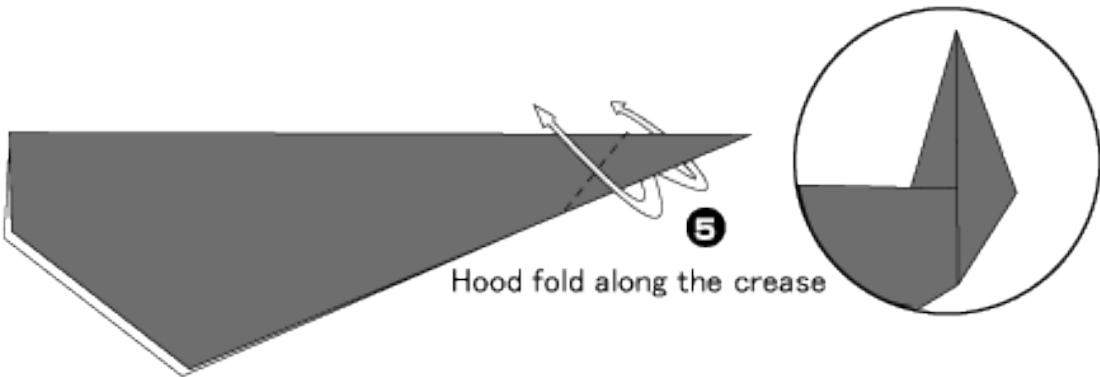

5 Hood fold along the crease

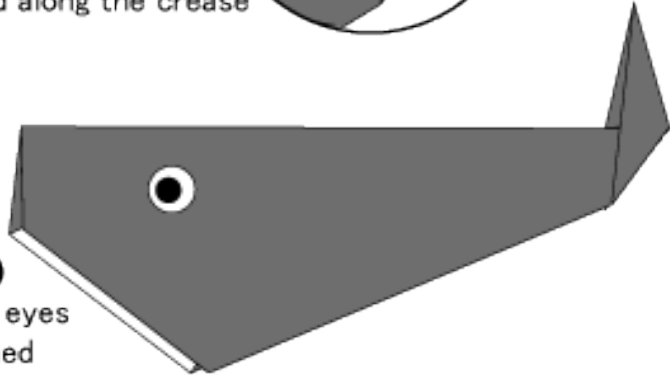

6 Stick the eyes and finished

A Whale

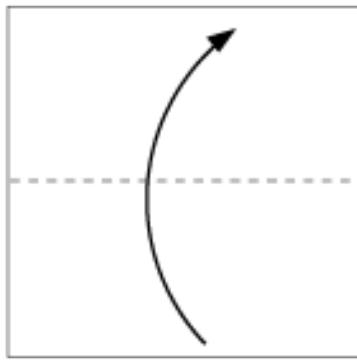

1 Fold in half



2 Fold in half

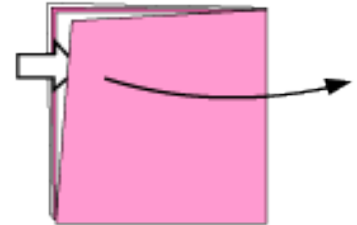

3 Open the part

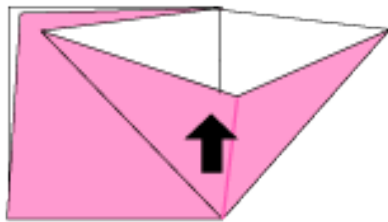

4 Flatten to square

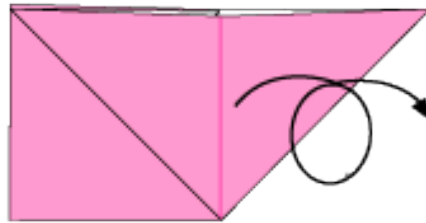

5 Turn over

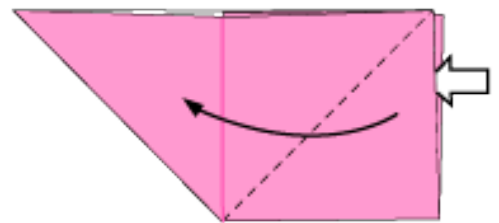

6 Open the part and flatten

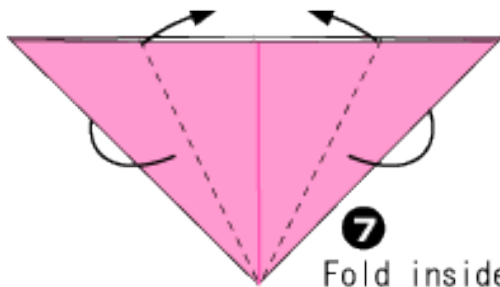

7 Fold inside in the dotted line

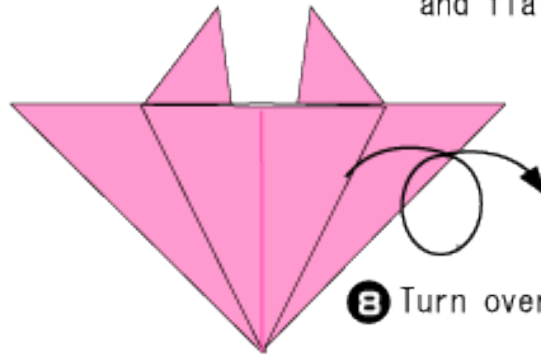

8 Turn over

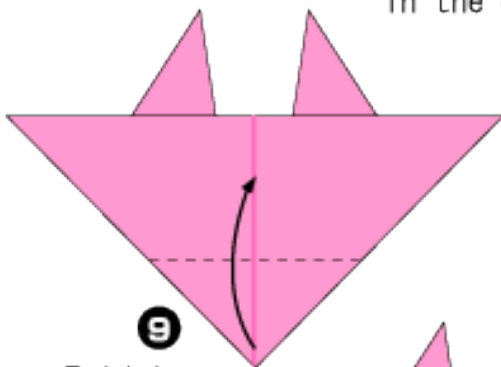

9 Fold in the dotted line

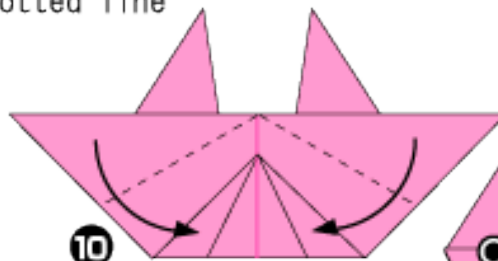

10 Fold in the dotted line

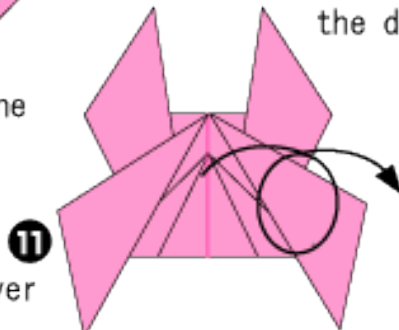

11 Turn over

12 Draw eyes and finished

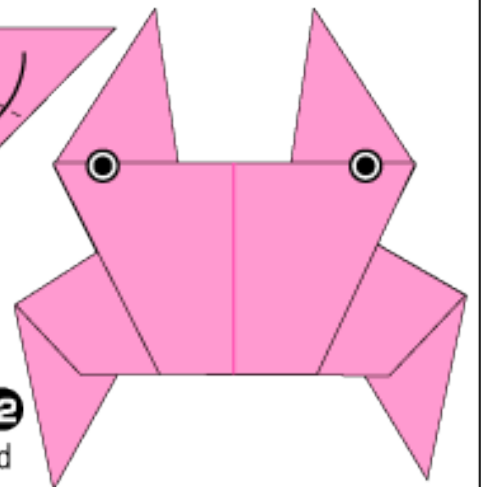

A Crab2

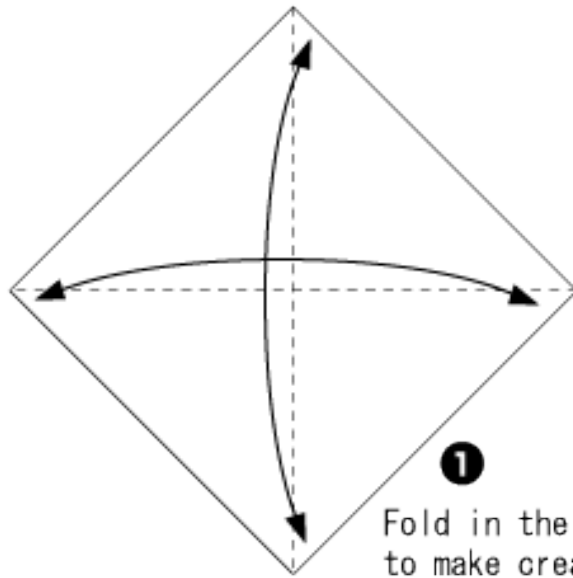

1
Fold in the dotted lines
to make creases and fold back

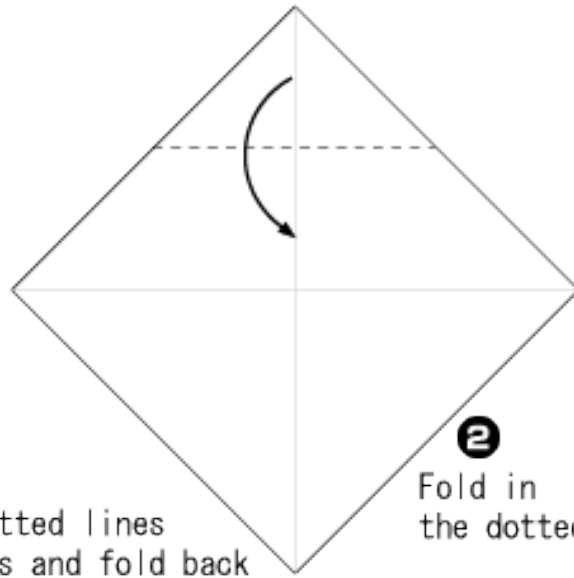

2
Fold in
the dotted line

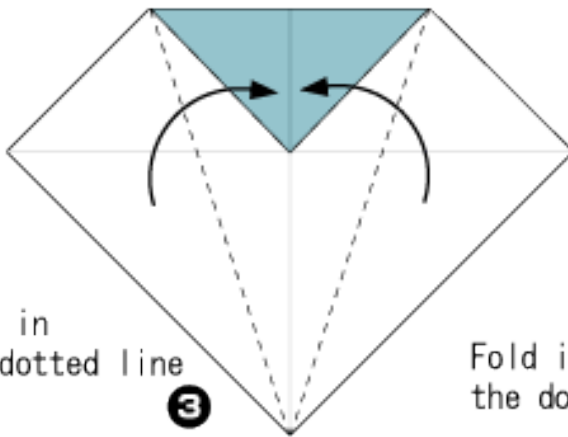

Fold in
the dotted line
3

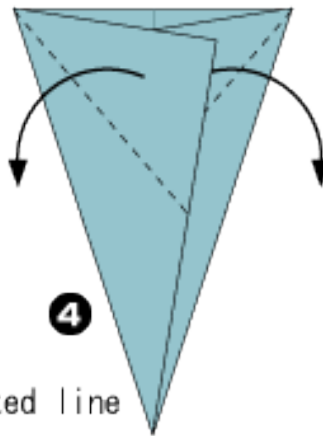

Fold in
the dotted line
4

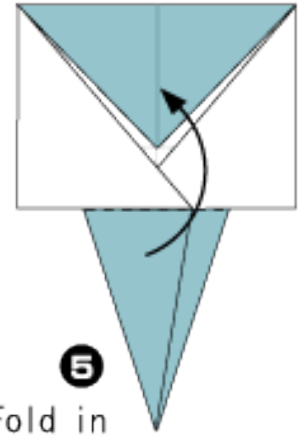

Fold in
the dotted line
5

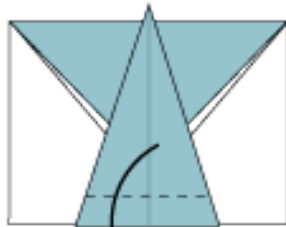

Fold in
the dotted line
6

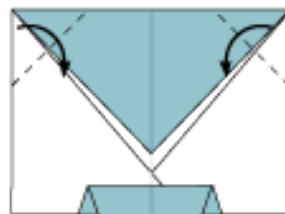

Fold in
the dotted line
7

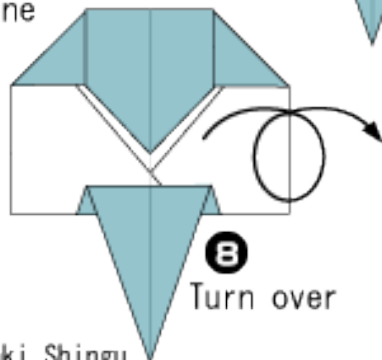

Turn over
8

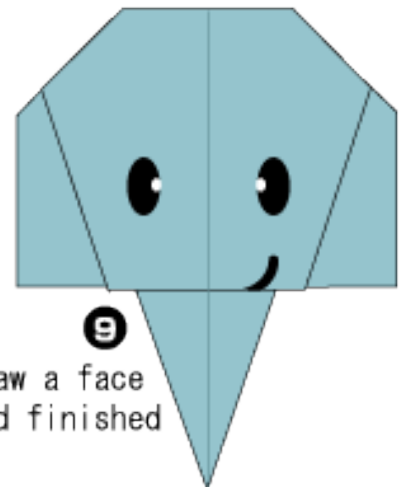

Draw a face
and finished
9

A Elephant (face)

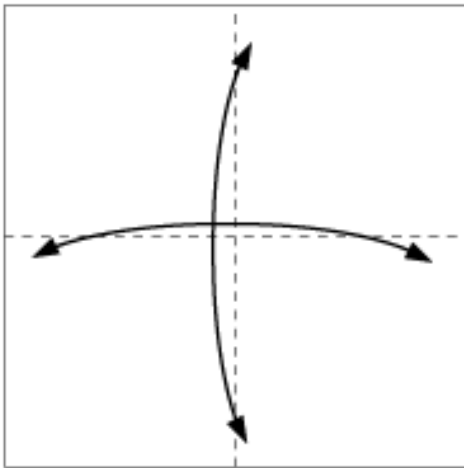

1 Fold in half twice to make creases and fold back

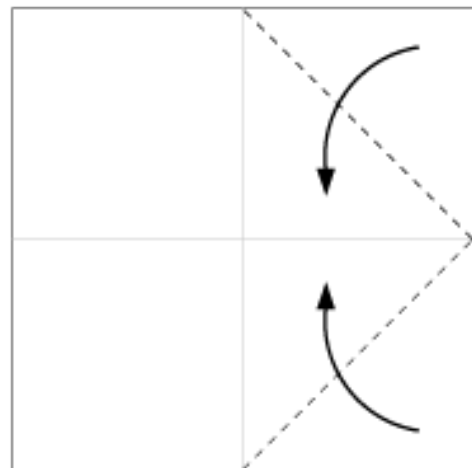

2 Fold in the dotted line

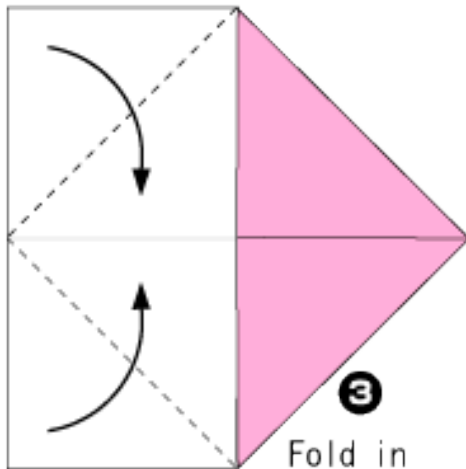

3 Fold in the dotted line

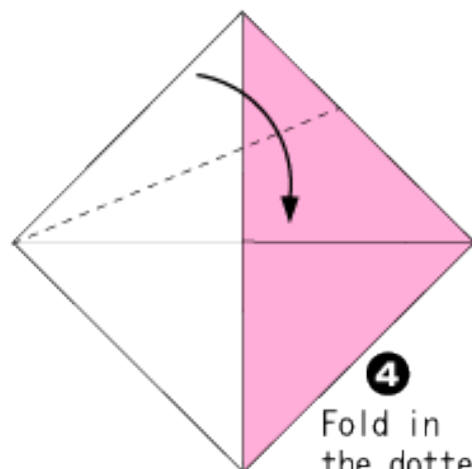

4 Fold in the dotted line

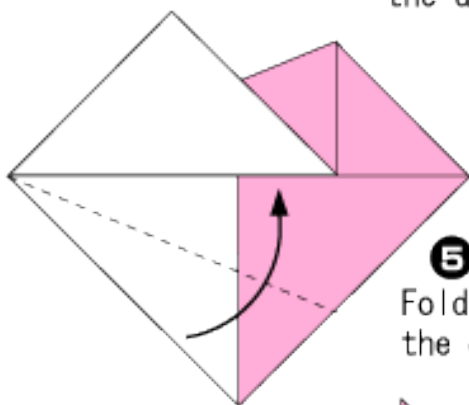

5 Fold in the dotted line

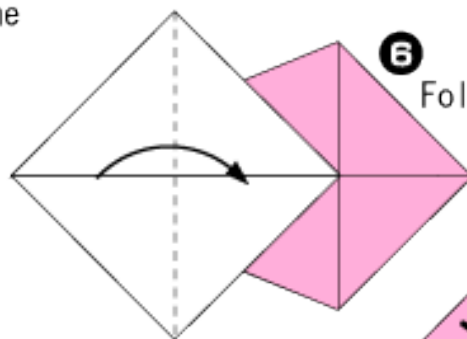

6 Fold in half

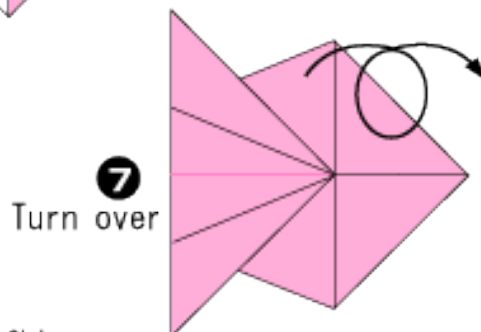

7 Turn over

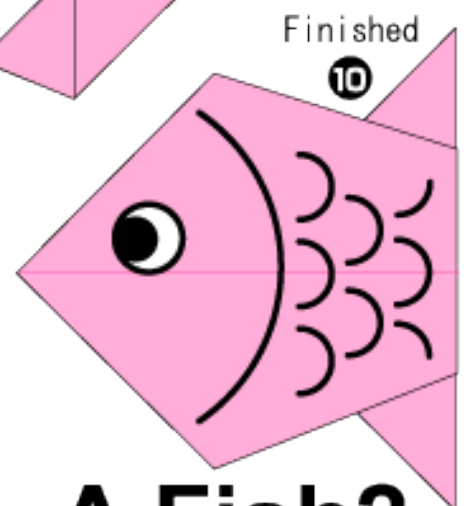

10

A Fish2

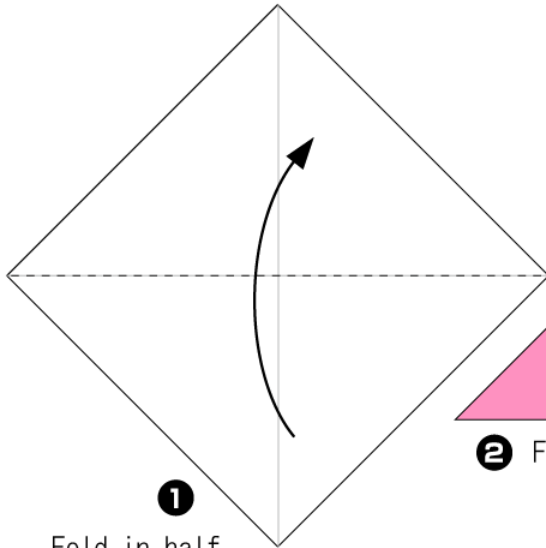

1
Fold in half

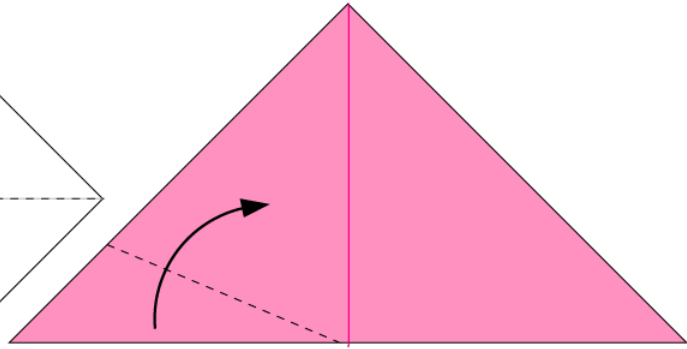

2 Fold in the dotted line

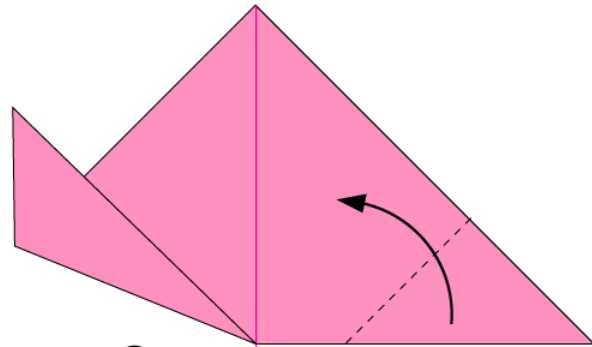

3 Fold in the dotted line

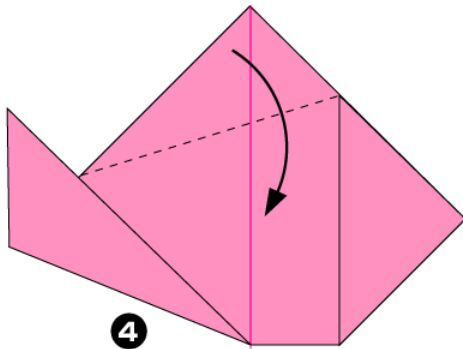

4
Both fold in the dotted line

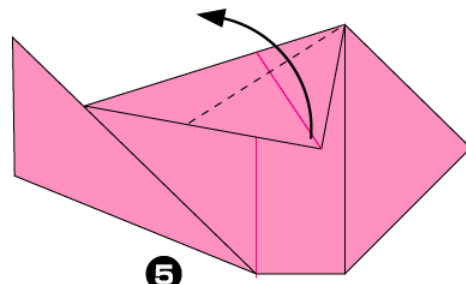

5
Both fold in the dotted line

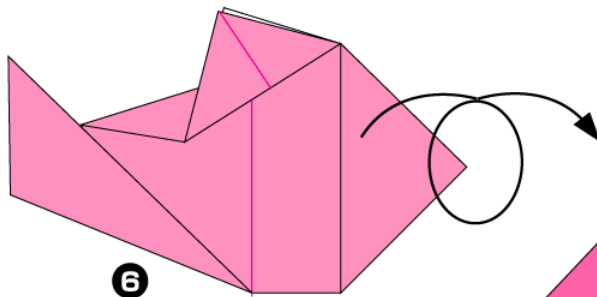

6
Turn over

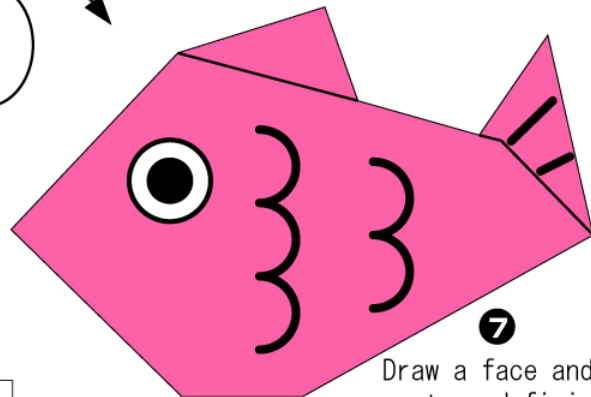

7
Draw a face and spots and finished



ORIGAMI CLUB

For more origami diagrams
en.origami-club.com

©Copyright:Fumiaki Shingu

Red snapper

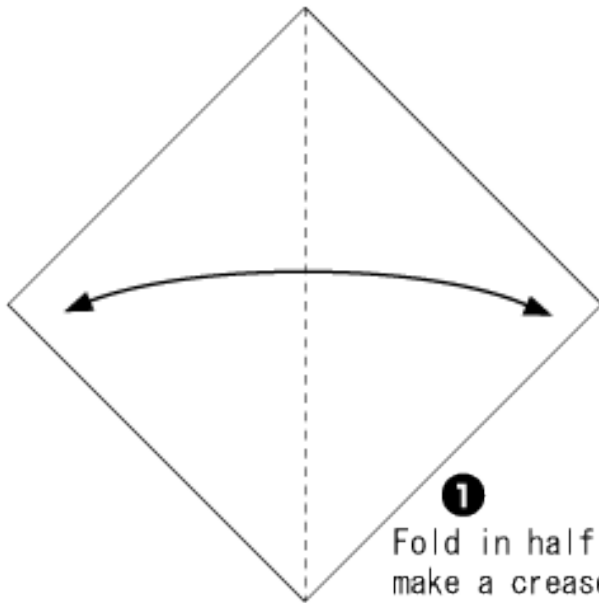

1
Fold in half to
make a crease and fold back

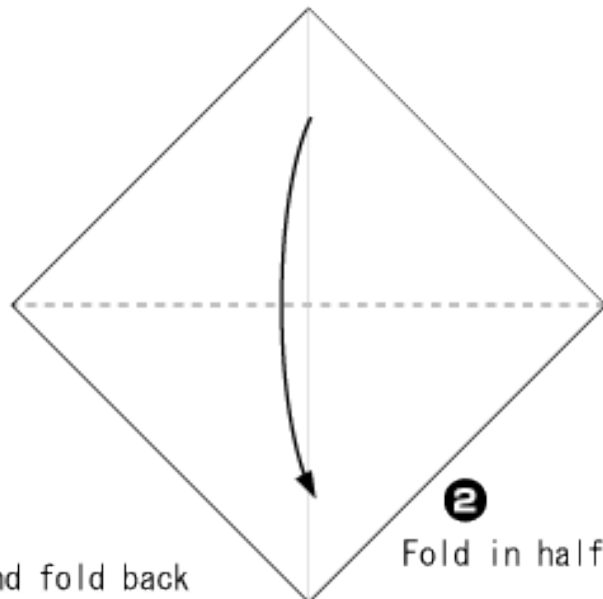

2
Fold in half

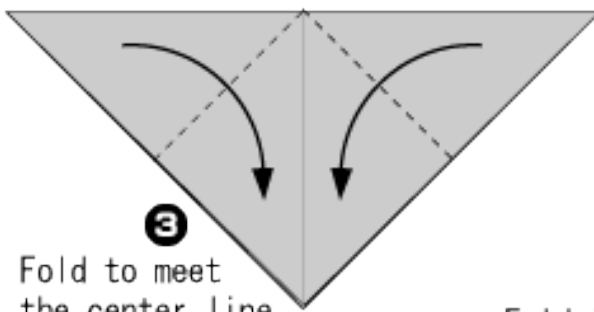

3
Fold to meet
the center line

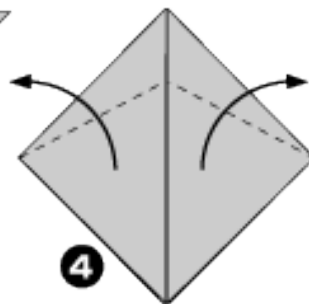

4
Fold in the dotted line

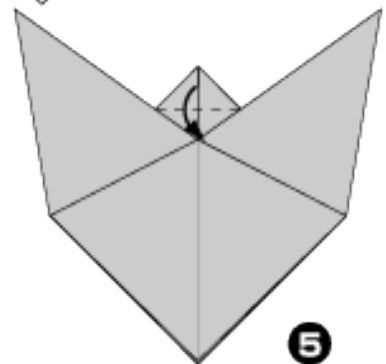

5
Fold in the dotted line

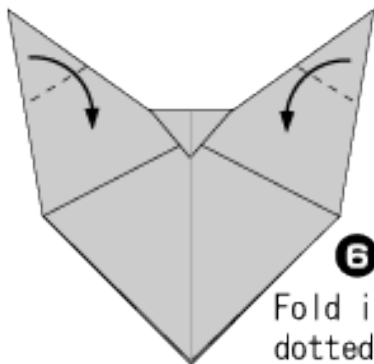

6
Fold in the
dotted line

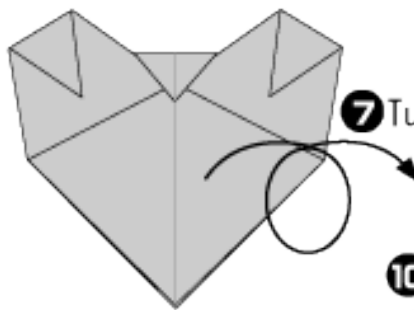

7 Turn over

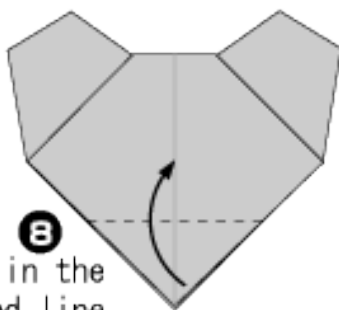

8
Fold in the
dotted line

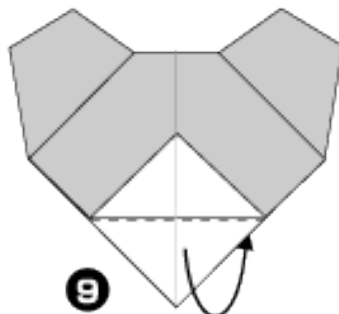

9
Fold backward
in the dotted line

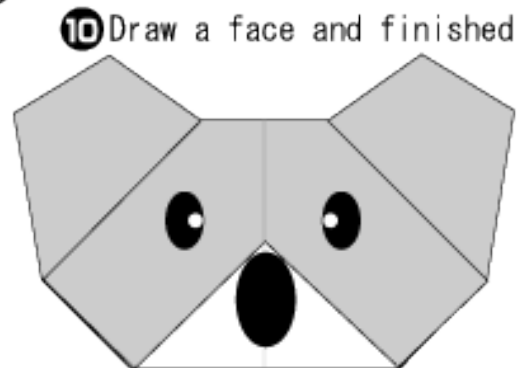

10 Draw a face and finished

A koala (face)

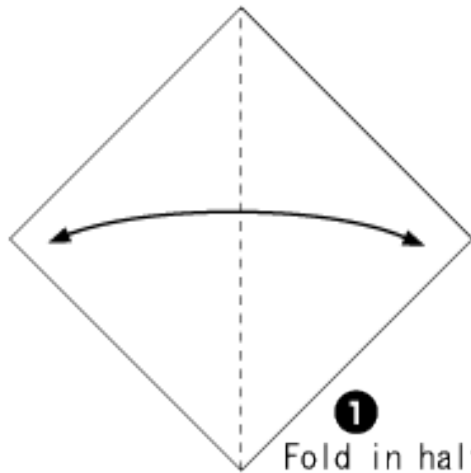

1 Fold in half to make a crease and fold back

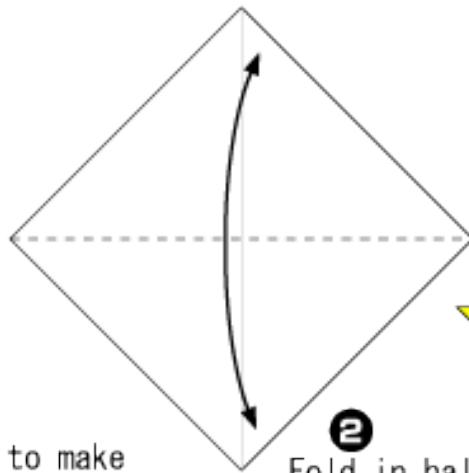

2 Fold in half

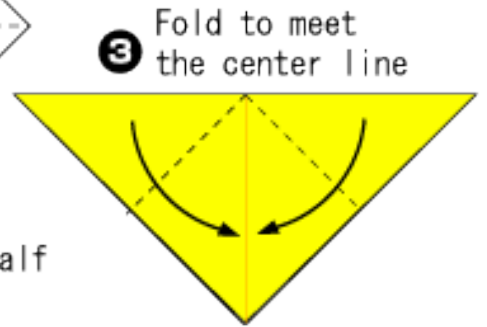

3 Fold to meet the center line

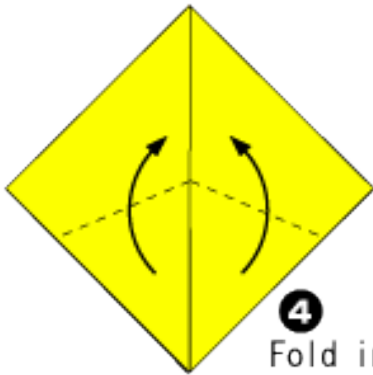

4 Fold in the dotted line

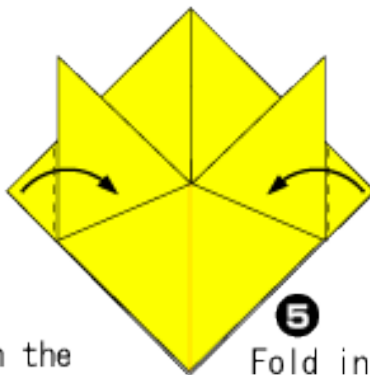

5 Fold in the dotted line

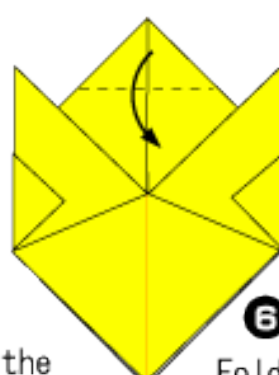

6 Fold in the dotted line

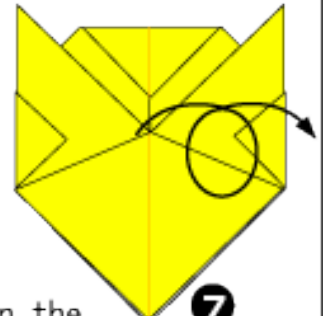

7 Turn over

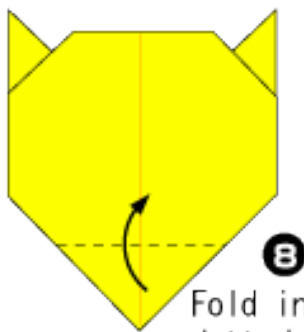

8 Fold in the dotted line

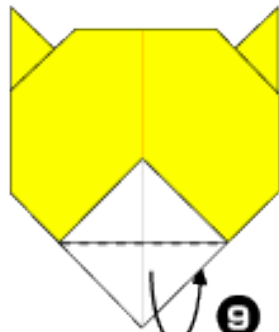

9 Fold backward in the dotted line

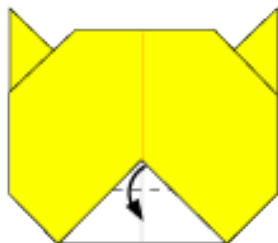

10 Fold in the dotted line

Draw a face and pattern and finished

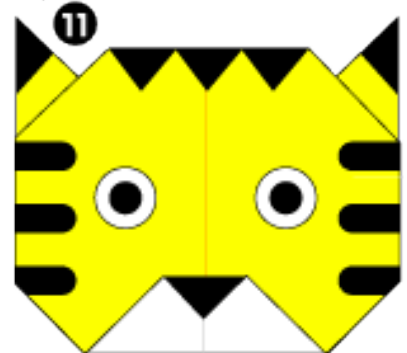

A Tiger(face)

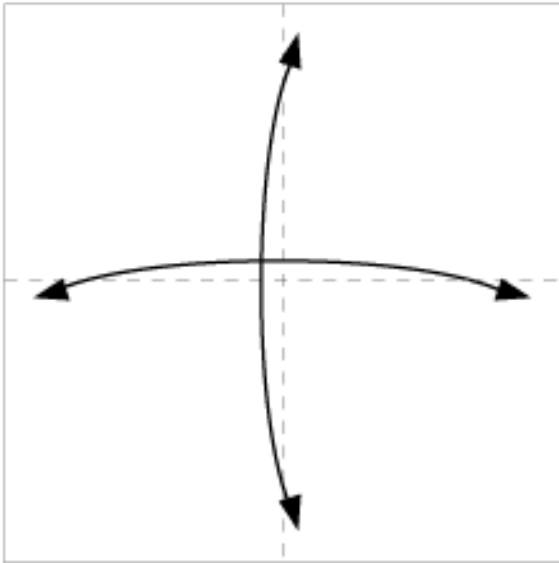

1 Fold in the dotted lines to make crease and fold back

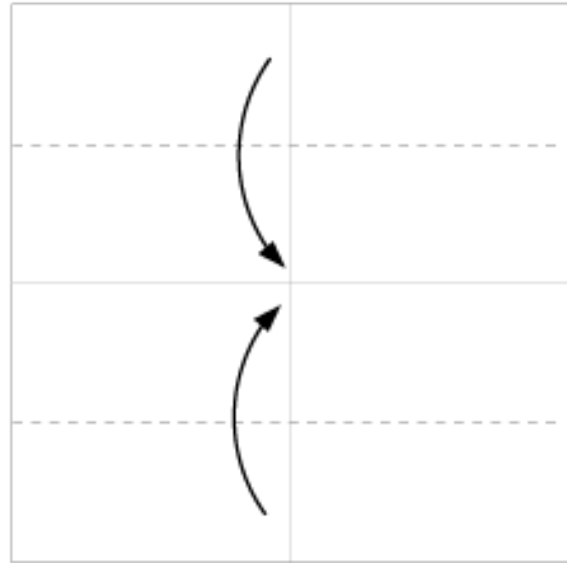

2 Fold in the dotted lines to meet the center line



3 Fold in the dotted lines

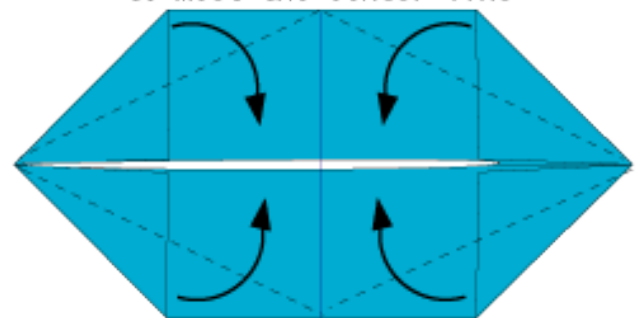

4 Fold in the dotted lines

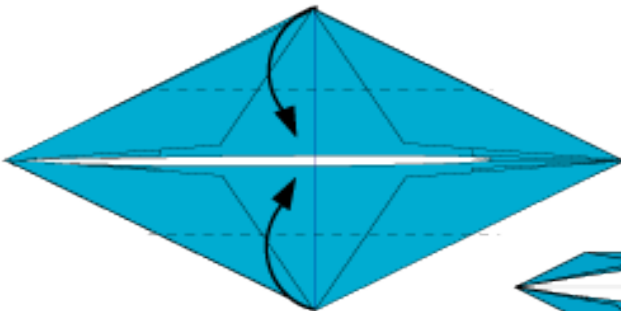

5 Fold in the dotted lines

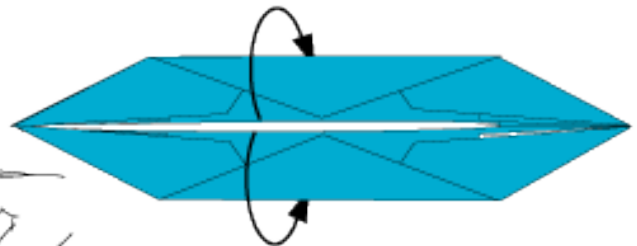

6 Open the pocket and turn inside out

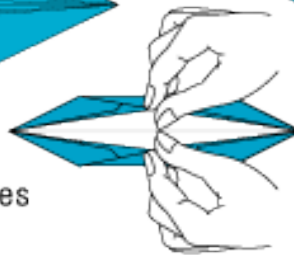

7 Finished



A Boat

*Traditional
Diagram:Fumiaki Shingu

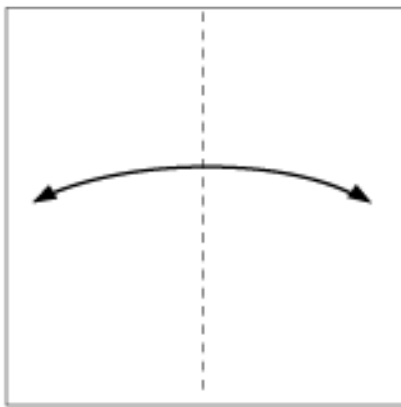

1 Fold in half to make creases and fold back

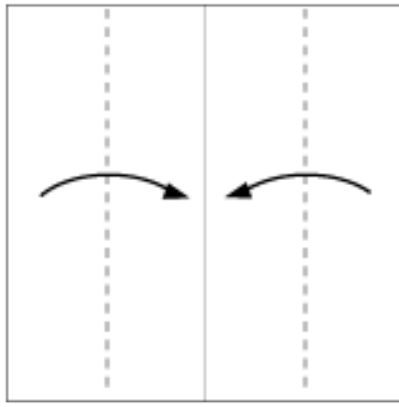

2 Fold in the dotted line to meet the center line



*Copyright: Fumiaki Shingu

3 Fold to make creases and fold back

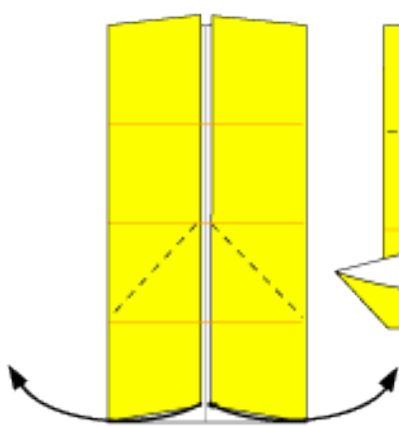

4 Open the corners and fold forward

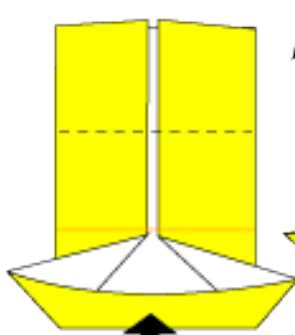

5 Flatten

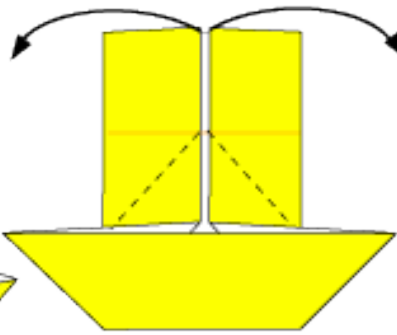

6 Open and flatten like Fig. 4 & 5

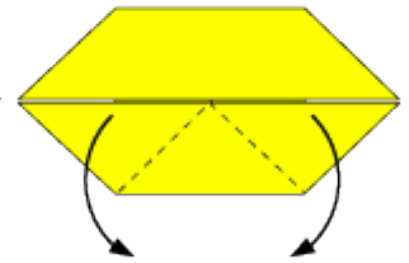

7 Fold in the dotted line

*Traditional Diagram: Fumiaki Shingu

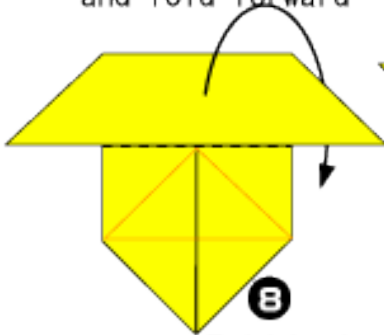

8 Fold backward in the dotted lines

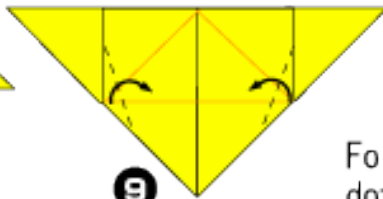

9 Fold in the dotted lines

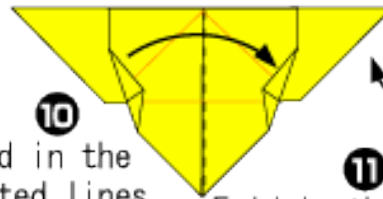

10 Fold in the dotted lines



11 Fold in the dotted lines

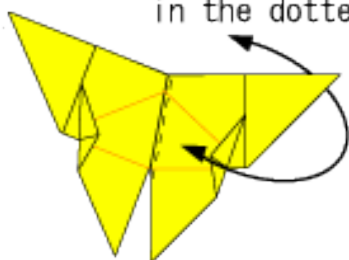

12 Fold to make crease and fold back

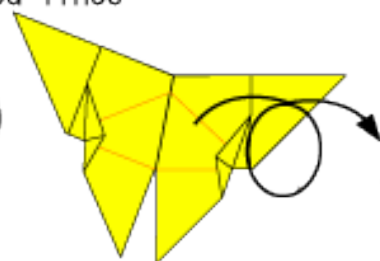

13 Turn over

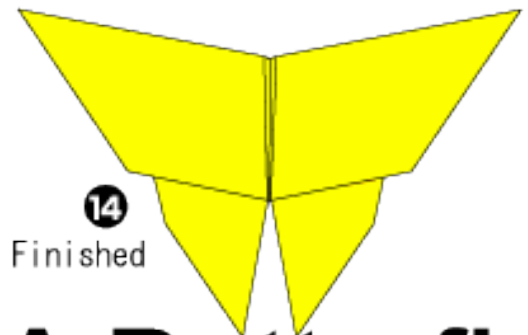

14 Finished

A Butterfly

*Traditional Diagram: Fumiaki Shingu

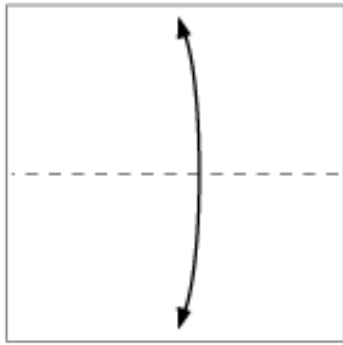

1 Fold in half to make crease

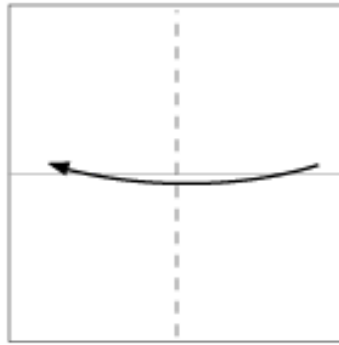

2 Fold in half



3 Fold to make crease and fold back



4 Fold to make crease and fold back

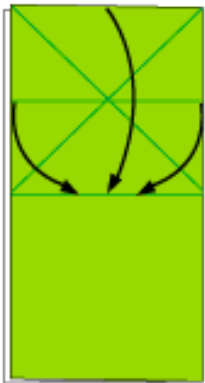

5 Fold in the lines

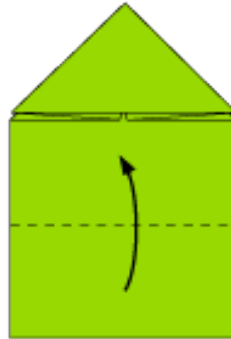

6 Fold in the dotted line

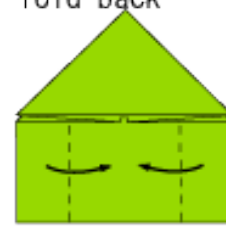

7 Fold in the dotted lines to meet the center

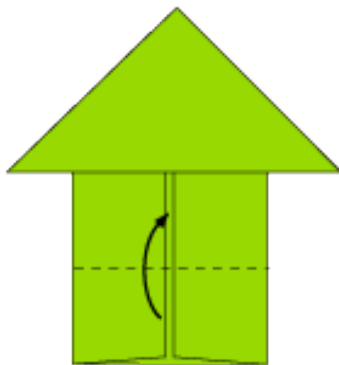

8 Fold in the dotted line

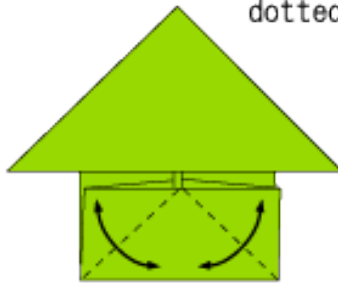

9 Fold in the dotted line and fold back

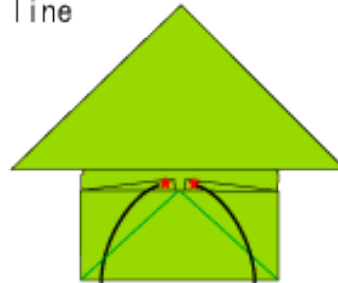

10 Pull out the corners

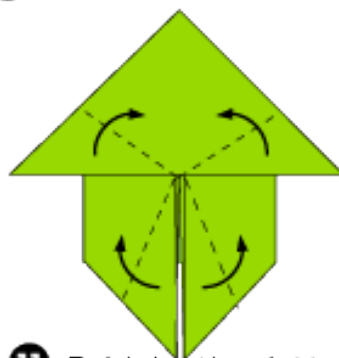
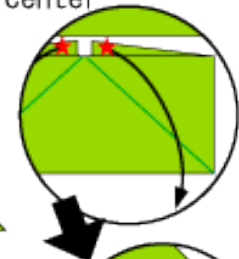

11 Fold in the dotted line

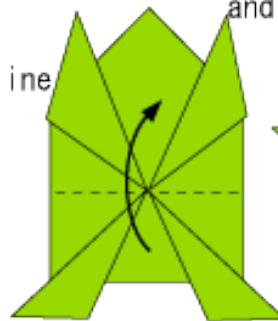

12 Fold in the dotted line



13 Fold in the dotted line



* Hold with a finger and release to jump



14 Turn over

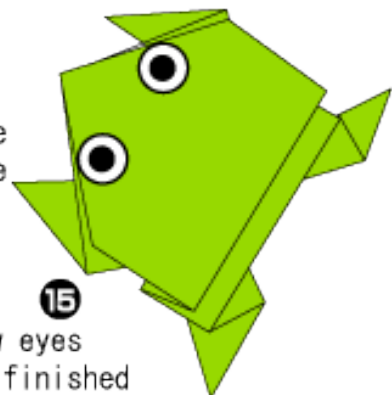

15 Draw eyes and finished

A Jumping Frog

★Prepare two origami papers

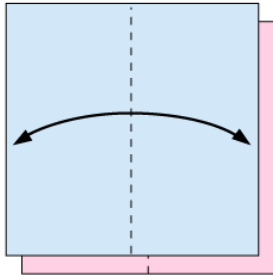

1 Fold in half to make a crease and fold back

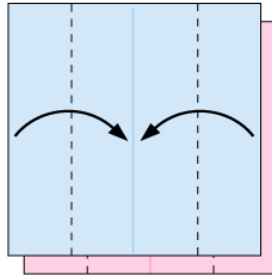

2 Fold to meet the center line

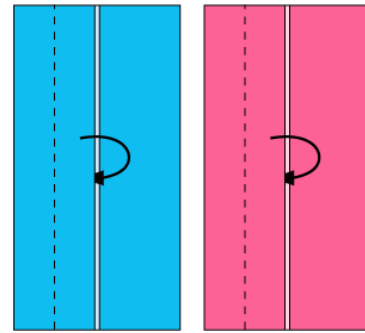

3 Fold inside in the dotted line

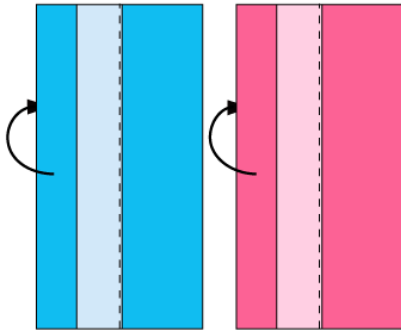

4 Fold backward in half

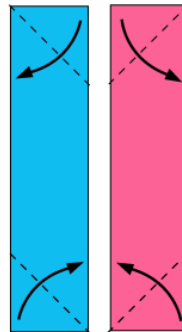

5 Fold in the dotted line

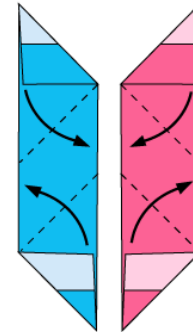

6 Fold in the dotted line

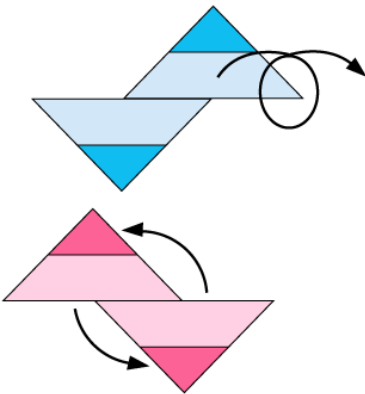

7 The blue one turn over and the red one turn around

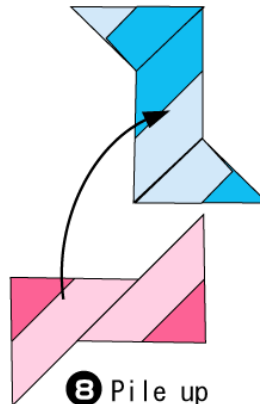

8 Pile up

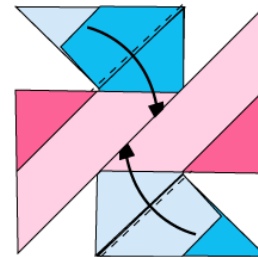

9 Fold and inserts it

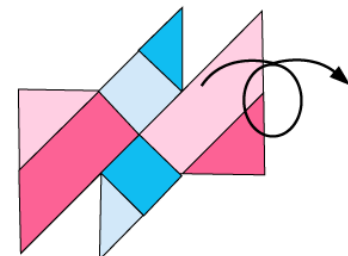

10 Turn over

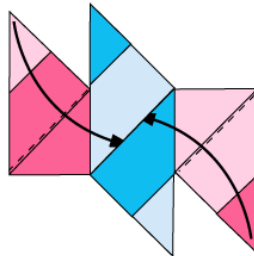

11 Fold and inserts it

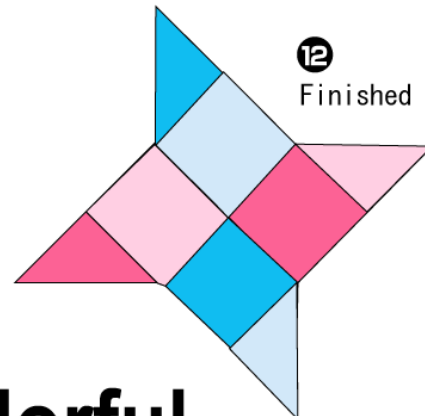

12 Finished



ORIGAMI CLUB

For more origami diagrams
en.origami-club.com

©Copyright:Fumiaki Shingu

Colorful Ninja Shuriken

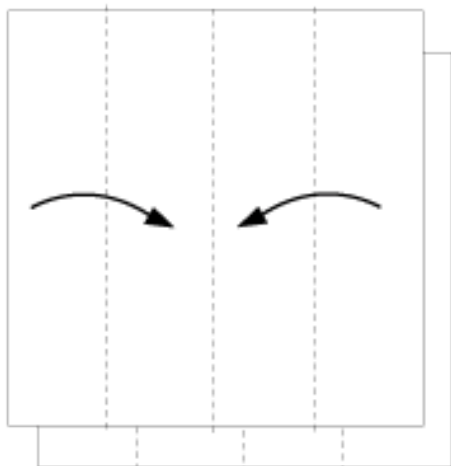

1 Fold in the dotted line

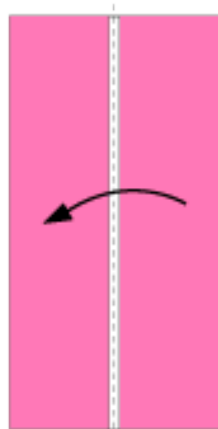

2 Fold in the dotted line



3 Fold in the dotted line

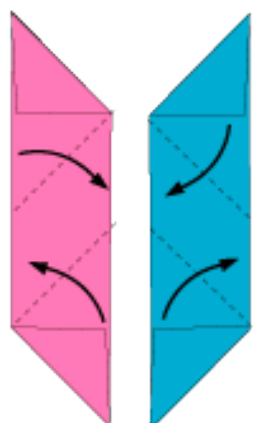
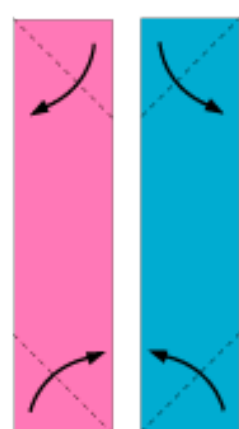

4 Fold in the dotted line

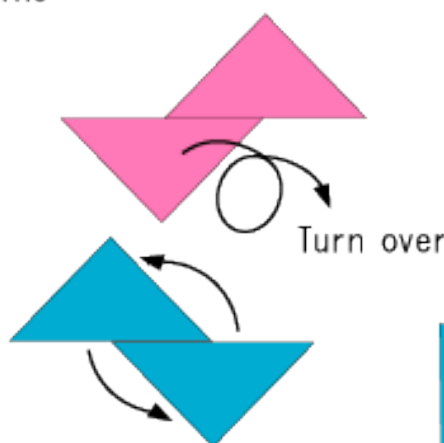

5 Turn around

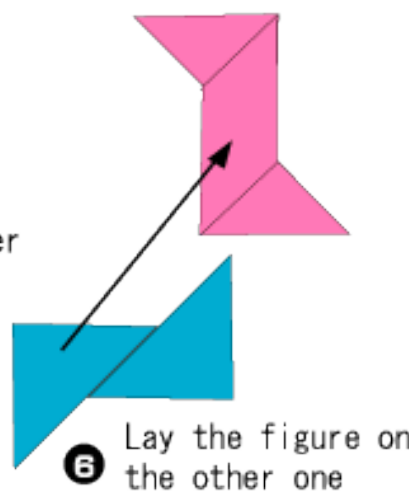

6 Lay the figure on the other one

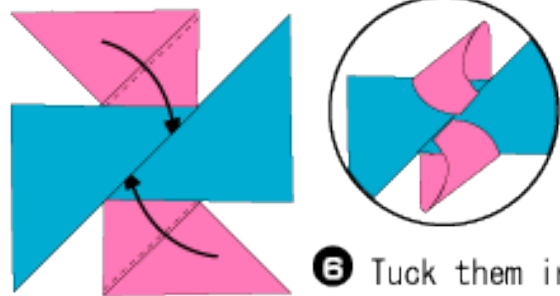

7 Tuck them into the pocket

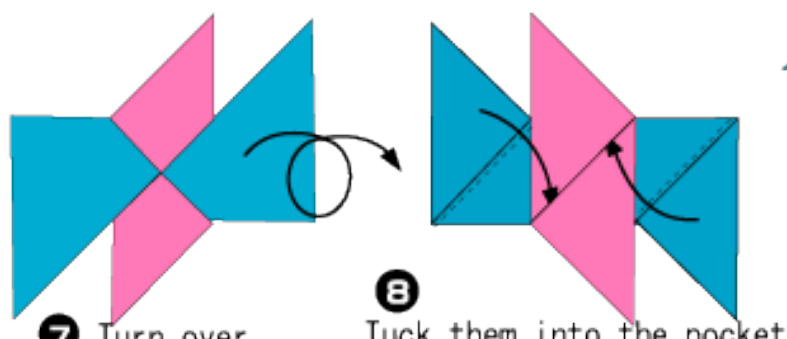

7 Turn over

8 Tuck them into the pocket



9 Finished

Shuriken (aka. Ninja Star)

*Traditional
Diagram: Fumiaki Shingu

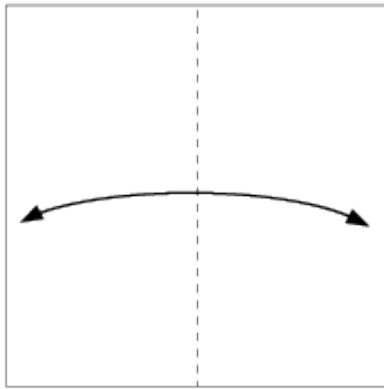

1 Fold in half twice to make creases and fold back

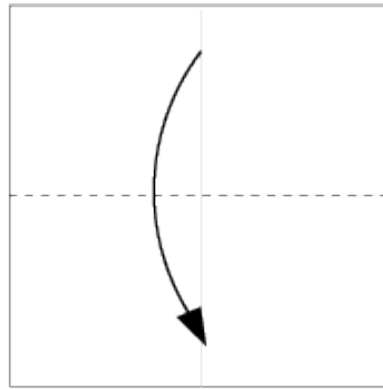

2 Fold in half

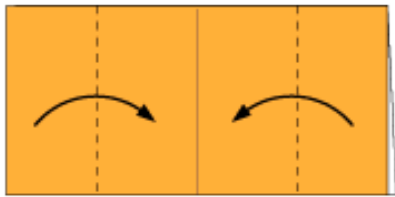

3 Fold to meet the center line

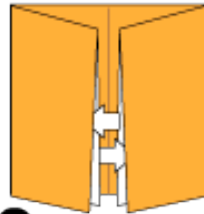

4 Open the ↑ part and flatten

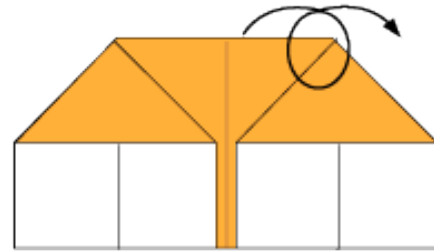

5 Turn over

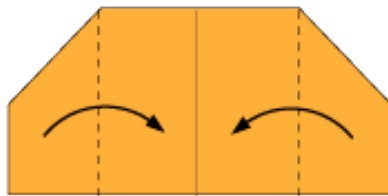

6 Fold to meet the center line

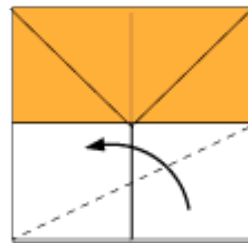

7 Fold

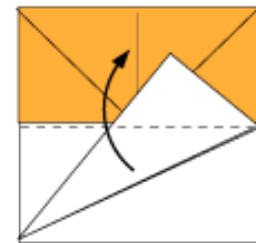

8 Fold

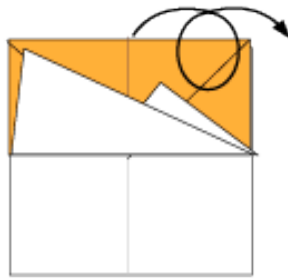

9 Turn over

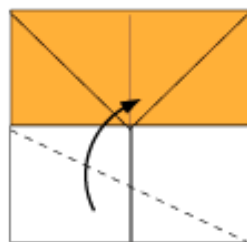

10 Fold

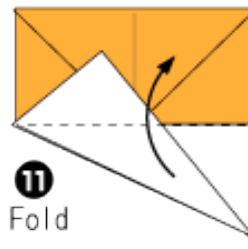

11 Fold

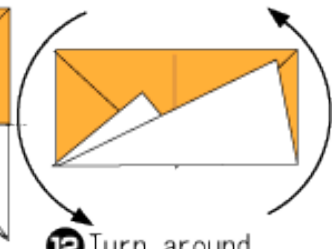

12 Turn around

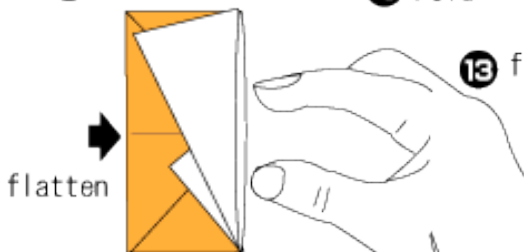

13 finger is put in

It fluctuates with the thumb and a finger



14

Draw eyes and finished



15

Talkative fox

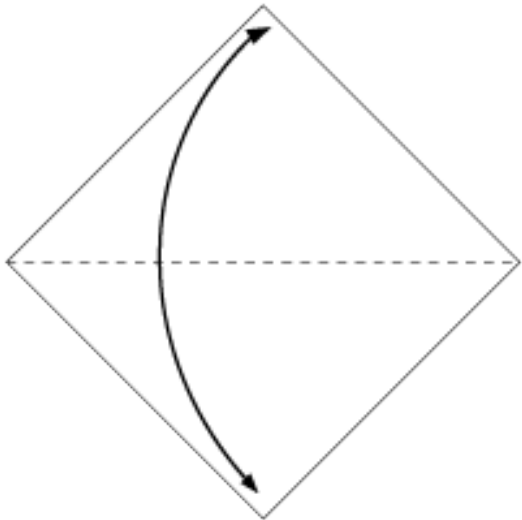

1 Fold in half to make crease and fold back

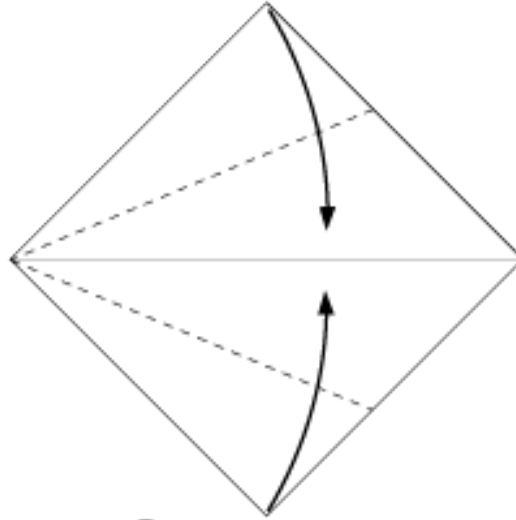

2 Fold in the dotted lines to meet the center line

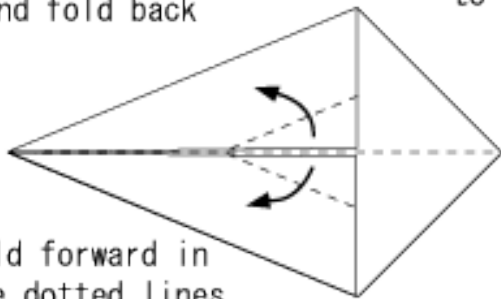

3 Fold forward in the dotted lines

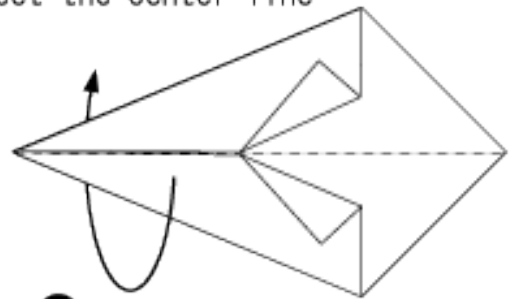

4 Fold in half

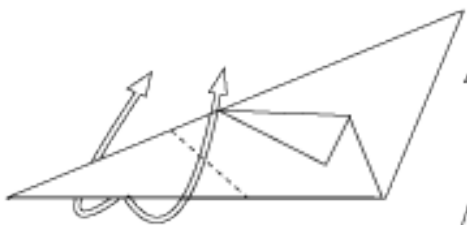

5 Hood fold in the dotted line

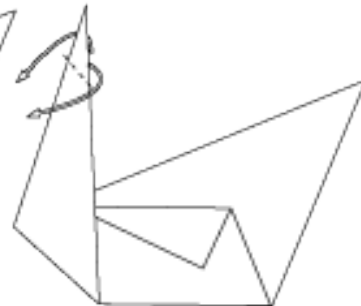

6 Hood fold in the dotted line

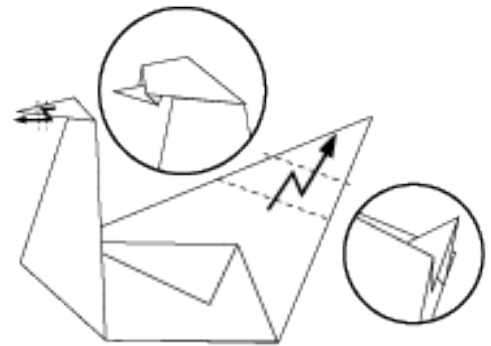

7 Pocket fold

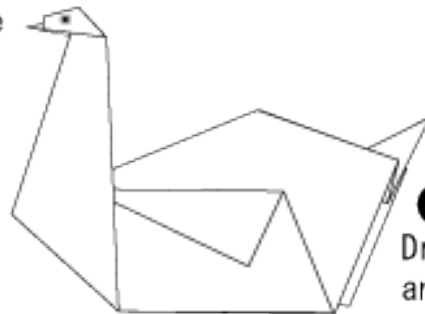

8 Draw eyes and finished

A Swan